

mattline
FURNITURE

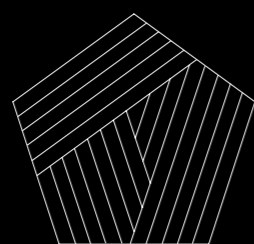

www.MATT-LINE.com
admin@matt-line.com
export@matt-line.com

**“Good design
is honest.”**

Dieter Rams

SPAIN OFFICE

Avenida generalitat valenciana nº40
castellón
SPAIN

USA OFFICE

Whitewater Ln, Oswego, IL 60543
USA

FACTORY

Barrio el Gamonal, 6, 39715 Ceceñas
Cantabria
SPAIN





The Birth of a Dream

INDEX

WHO WE ARE 08

TIME FRAME 10

MATERIALS LIBRARY 16

GENERAL OUTLINE 20

MEETING TABLES

VENECIA 26

FLORENCE 34

TORINO 42

COLISSEO 48

ROME 72

COPPOLA 80

FONTANA 86

VERONA 92

DESKS

VALENCIA 54

MADRID 60

BARCELONA 68

WHO WE ARE

We are a Spanish company (Santander and Castellón) with a strong international outlook, dedicated to the design and manufacture of exclusive furniture.

Our company offers technical support services for the development of custom products and interior design projects, with the aim of ensuring complete customer satisfaction through personalized and direct attention.

Somos una firma española (Santander y Castellón), con una clara vocación internacional, dedicada al diseño y fabricación de mobiliario exclusivo.

Nuestra empresa ofrece un servicio de soporte técnico en el desarrollo de productos a medida y proyectos de interiorismo, con la finalidad de garantizar la absoluta satisfacción del cliente, mediante un trato personalizado y directo.



reddot award 2018
winner



GERMAN
DESIGN
AWARD
NOMINEE
2019



PREMIO
ADCV 2019
ORO



TIME FRAME

At MATTLINE Furniture, our project methodology is carefully designed to ensure exceptional results at every stage, from the initial design to the final installation. We are committed to providing customized, high-quality solutions that exceed our clients' expectations, integrating functionality, aesthetics, and technology into a single process.

En MATTLINE Furniture, nuestra metodología de proyecto está cuidadosamente diseñada para garantizar resultados excepcionales en cada etapa, desde el diseño inicial hasta la instalación final. Nos comprometemos a ofrecer soluciones personalizadas y de alta calidad que superen las expectativas de nuestros clientes, integrando funcionalidad, estética y tecnología en un solo proceso.

Final client: Private offices in the UK



CLIENT

mattline
FURNITURE

1. DRAFT DESIGN

The client provides us with a sketch or image, and our design team refines and develops it into the final concept.

El cliente nos proporciona un boceto o una imagen, y nuestro equipo de diseño lo transforma y desarrolla.



2. MATERIAL LIBRARY

The client must choose the materials they wish to use for the new product.

El cliente debe elegir los materiales que desea aplicar al nuevo producto.



3. CONNECTIVITY

Configure according to your technological needs including connectivity boxes, grommets and pop-up/retractable monitors/displays. Configura según tus necesidades tecnológicas, incluyendo cajas de conectividad, pasacables y monitores/pantallas emergentes o retráctiles.



4. 3D DESIGN + DRAWINGS

We design and render the bespoke product, including the corresponding manufacturing drawings.

Diseñamos y renderizamos el producto a medida, incluyendo los planos de fabricación correspondientes.



5. MANUFACTURING

Throughout the manufacturing process, we send photos and videos to the client, allowing them to closely monitor the project's progress.

Durante el proceso de fabricación, enviamos fotos y videos al cliente para que pueda hacer un seguimiento detallado del proyecto.



6. TRANSPORT AND INSTALLATION

Should the client require it, we can install the product at the destination site or provide detailed assembly instructions.

Si el cliente lo requiere, podemos realizar la instalación del producto en el sitio de destino o enviar instrucciones detalladas de montaje.



Sample Project

4. 3D Design & Drawings

Each project is fully customized. We first model all products in 3D and then render them with the selected materials. Once approved, we create detailed drawings, providing a tailored project package for the client.

Cada proyecto es completamente personalizado. Primero modelamos en 3D todos los productos y luego los renderizamos con los materiales seleccionados. Una vez aprobados, elaboramos planos detallados, proporcionando un paquete de proyecto a medida para el cliente.

Final client: Ministry in Tunisia (2025)

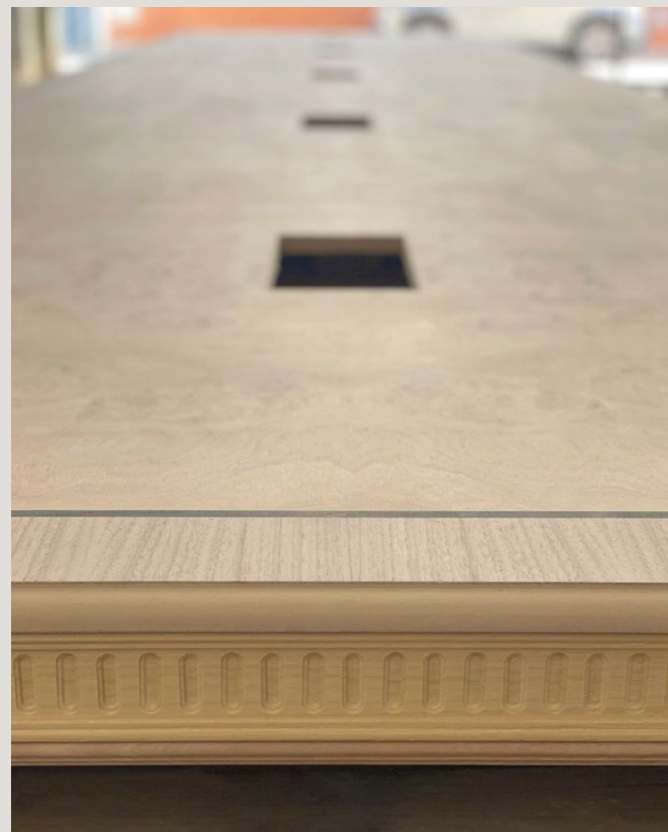

Final client: Family of the Emir of Qatar (2025)



Photo taken during the manufacturing process.
Foto tomadas durante el proceso de fabricación.

Sample Project

5. During the manufacturing process

Marquetry table (without joints) made of ebony, clear oak, black lacquer and gold leaf. A perfect example where the level of detail is extremely high to satisfy the most refined and demanding clients.

Mesa de marquetería (sin juntas) realizada de ebano, roble claro, lacado negro y pan de oro. Ejemplo perfecto donde el nivel de detalle es altísimo para satisfacer a los clientes mas refinados e exigentes.

Final client: Family of the Emir of Qatar (2025)

<https://mattlinedotcom.wordpress.com/wp-content/uploads/2024/12/mtm.mp4>



MARQUETRY Meeting Table WITHOUT JOINS



Photos taken during the manufacturing process. Fotos tomadas durante el proceso de fabricación.

Sample Project

6. During the manufacturing process

The meeting table is crafted from crown-cut walnut, showcasing a continuous grain that runs along the entire length of the tabletop, enhancing the natural elegance of the wood. At its center, it features an inlay of natural black leather, seamlessly integrating the connection boxes.

The structure stands on oblique legs in a matte black lacquered finish, adding a contemporary and sophisticated character. To ensure maximum stability, the table includes an internal metal frame that increases its rigidity and strength.

As a distinctive detail, the tabletop edge features a double 45° beveled walnut profile, completing the design with a refined and artisanal finish.

Final client: Public Investment Fund (PIF) (2025)

https://mattlinedotcom.wordpress.com/wp-content/uploads/2024/12/mattline_pif.mov



Size = 5 x 2 m



Photos taken during the manufacturing process.
Fotos tomadas durante el proceso de fabricación.



Sample Project

6. During the manufacturing process



Photos taken during the manufacturing process.
Fotos tomadas durante el proceso de fabricación.



MATERIALS LIBRARY

At MATTLINE Furniture, we specialize in offering custom-made and fully personalized materials to meet the most demanding needs of our clients. We offer a wide range of options that allow us to create unique products tailored to each project, where quality and design are our priority. Among the most notable materials we offer are natural wood or melamine, marble or porcelain, natural or synthetic leather, metals, and lacquer finishes, all of which can be fully customized.

En MATTLINE Furniture, nos especializamos en ofrecer materiales a medida y completamente personalizados para satisfacer las necesidades más exigentes de nuestros clientes. Contamos con una amplia gama de opciones que permiten crear productos únicos, adaptados a cada proyecto, donde la calidad y el diseño son nuestra prioridad. Entre los materiales más destacados que ofrecemos se encuentran la madera natural o melamina, mármol o porcelánico, piel natural o artificial, metales y lacados de pintura, todos ellos con la posibilidad de personalización total.

veneER

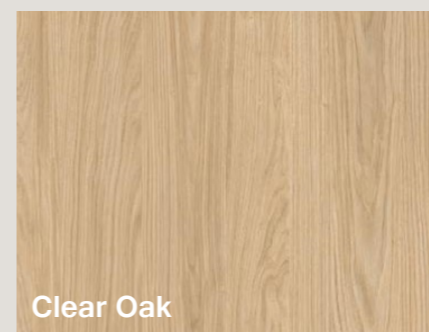

Clear Oak

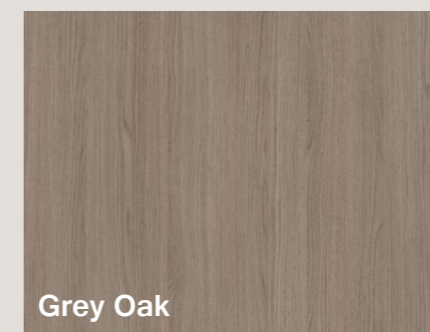

Grey Oak

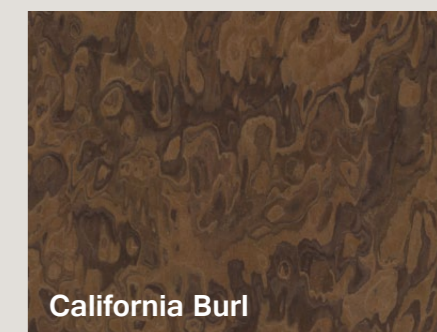

California Burl

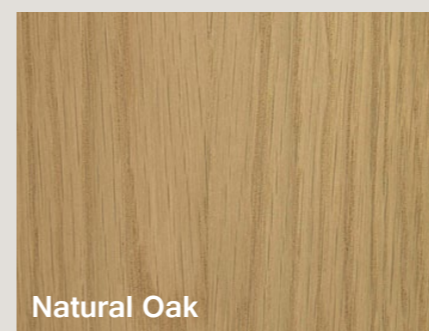

Natural Oak

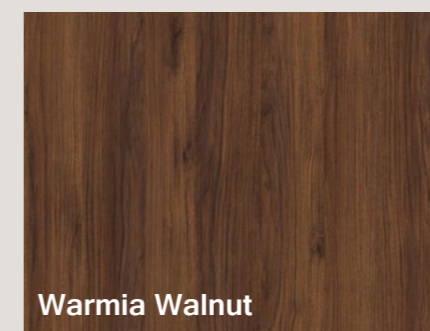

Warmia Walnut

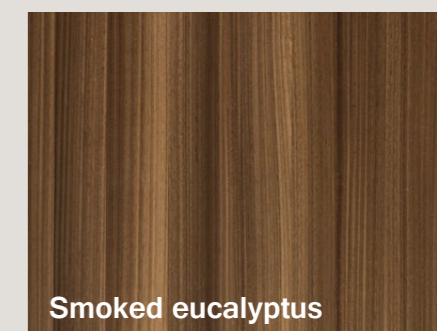

Smoked eucalyptus

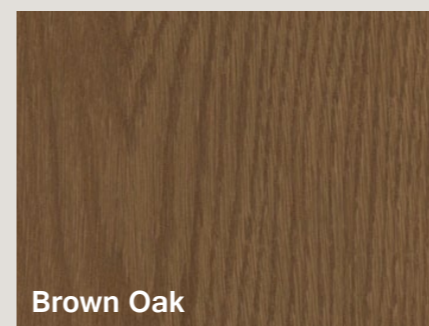

Brown Oak

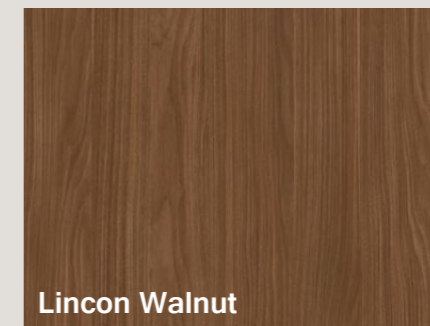

Lincon Walnut

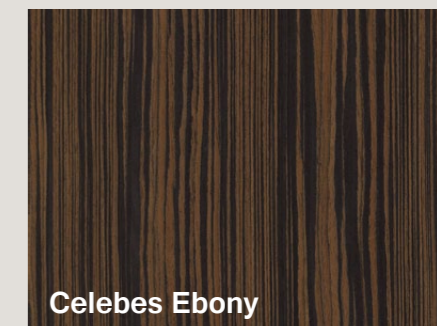

Celebes Ebony

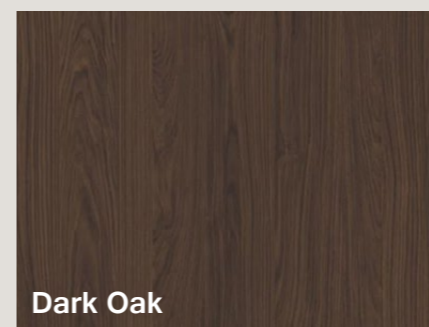

Dark Oak

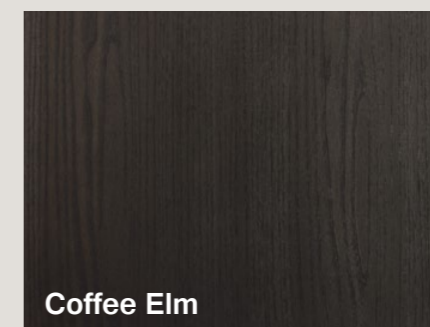

Coffee Elm

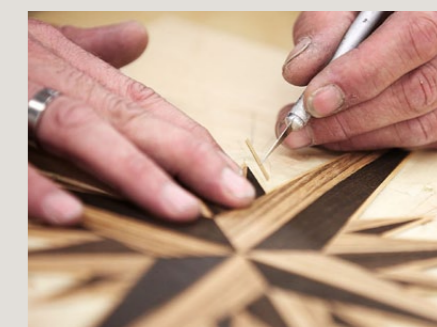

Marquetry



Quarter-cut and crown-cut available options

METAL

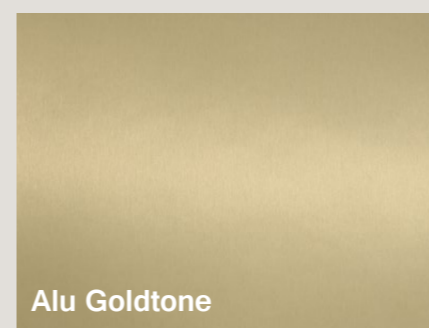

Alu Goldtone

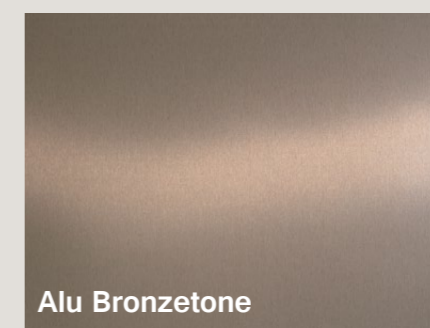

Alu Bronzestone

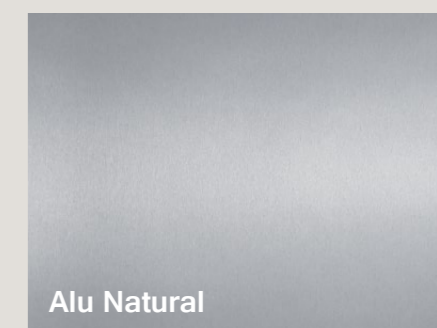

Alu Natural

LACQUERED



Pure White

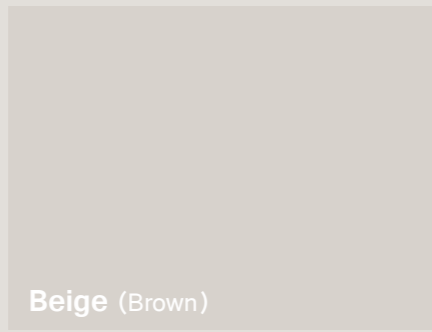

Beige (Brown)

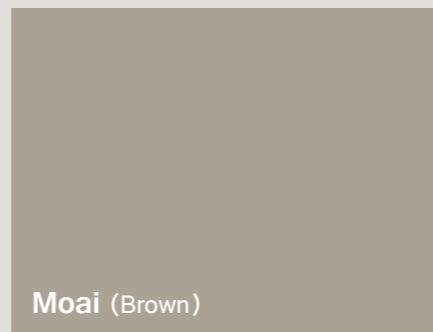

Moai (Brown)

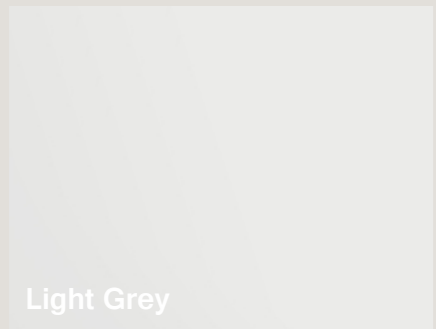

Light Grey

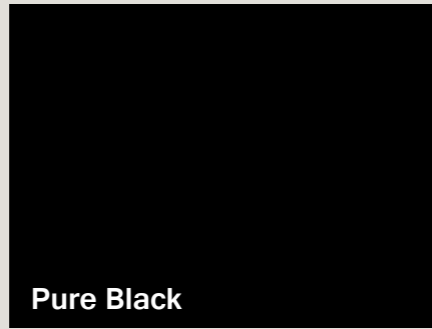

Pure Black



Taupe (Brown)

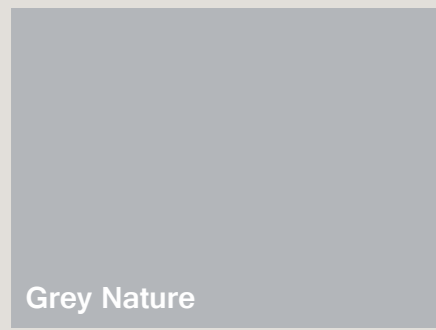

Grey Nature



Dark Grey

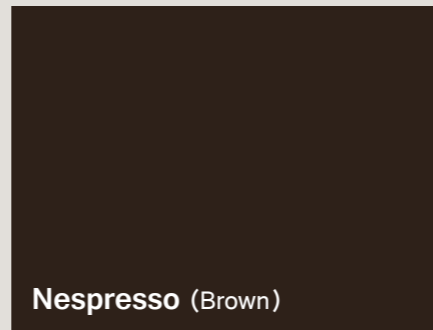

Nespresso (Brown)



Finish options range from matt to high gloss

MARBLE

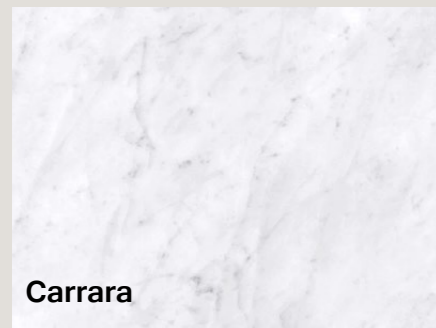

Carrara



Calacatta



Calacatta Gold



Finish options range from matt to high gloss & bookmatch

LEATHER



Snow 026



Alabaster 025



Oyster 007

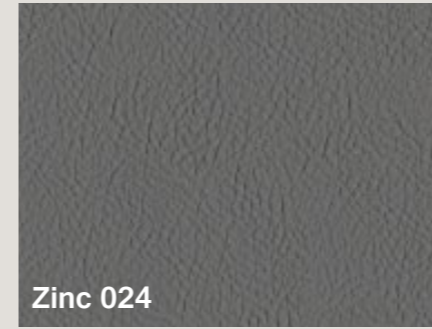

Zinc 024

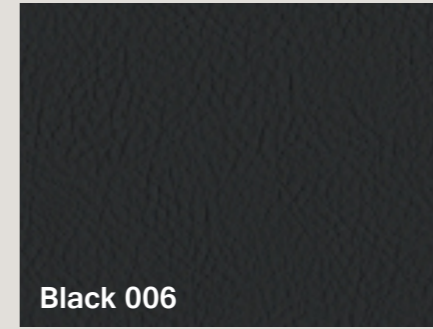

Black 006



Taupe 010



Camel 001



Mahogany 015



Chocolate 011



Natural and synthetic leather available options

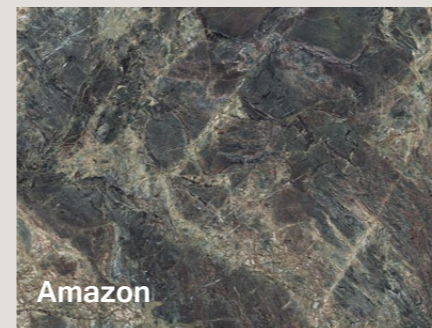

Amazon

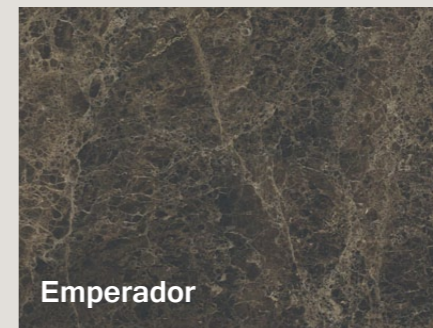

Emperador

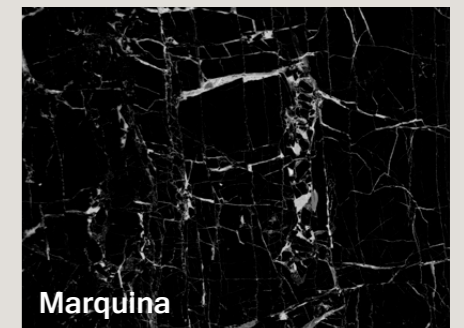

Marquina

GENERAL OUTLINE

To offer a comprehensive overview of the entire MATTLINE Furniture collection, we have prepared a detailed dossier showcasing our products. This material enables the client to explore the available options and choose the product that best fits the needs and specifications of their project, ensuring an informed decision that aligns with their requirements.

Con el fin de ofrecer un vistazo detallado a toda la colección de la empresa MATTLINE Furniture, hemos preparado un completo dossier que presenta nuestros productos. Este material permitirá al cliente explorar las opciones disponibles y seleccionar el producto que mejor se ajuste a las necesidades y características de su proyecto, asegurando una elección informada y adecuada a sus requerimientos.



Verona

Pag 98

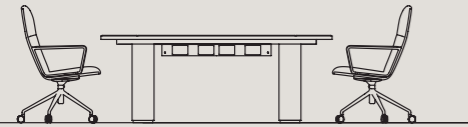
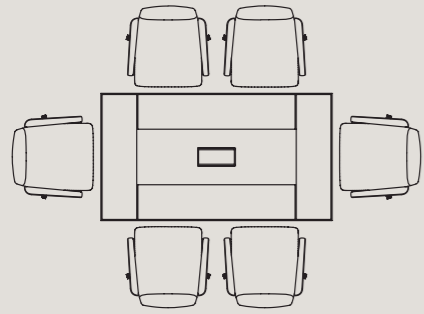

Venecia

Pag 26

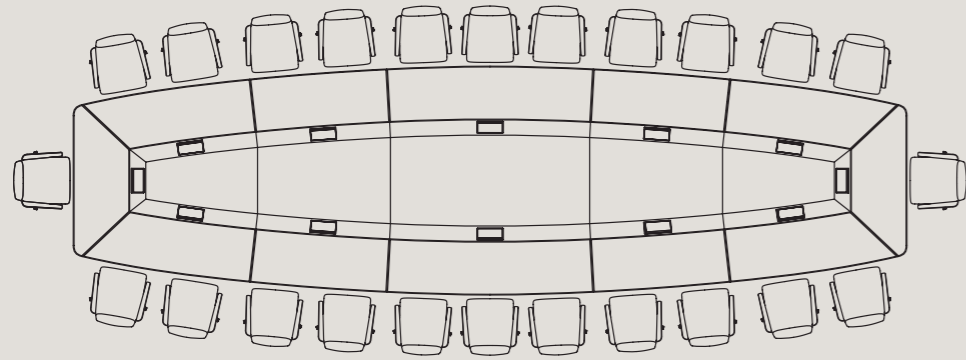

Coppola

Pag 80

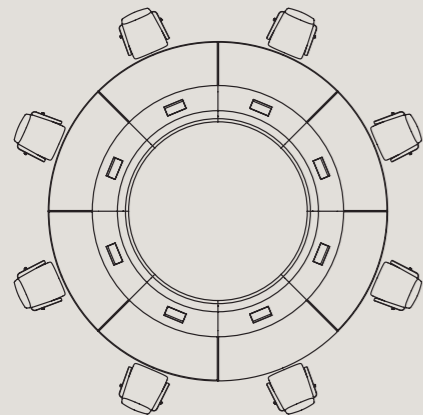

Florence

Pag 34

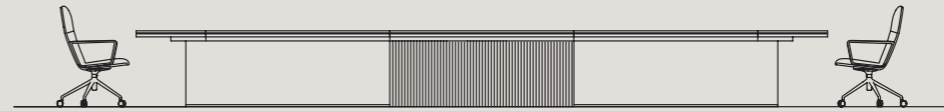
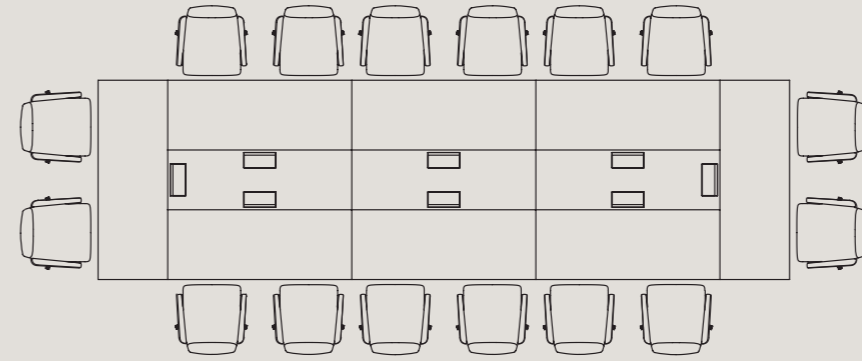

Rome

Pag 72

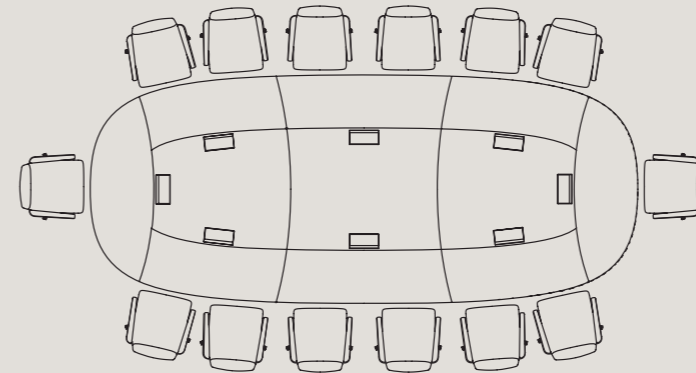

Fontana

Pag 86

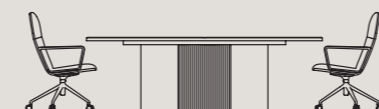
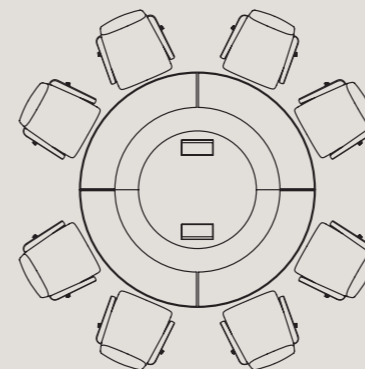

Napoli

Pag 92

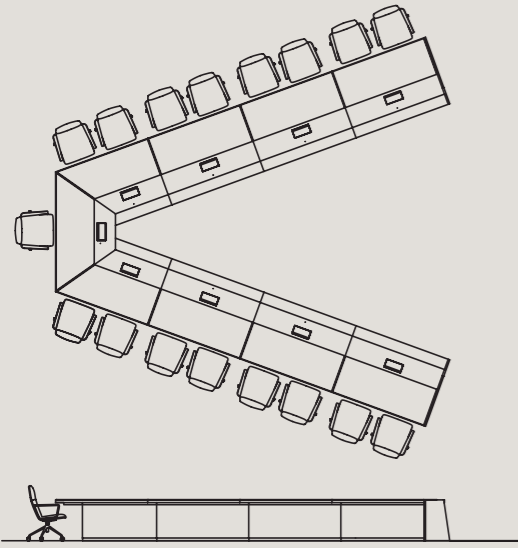

Coliseo

Pag 48

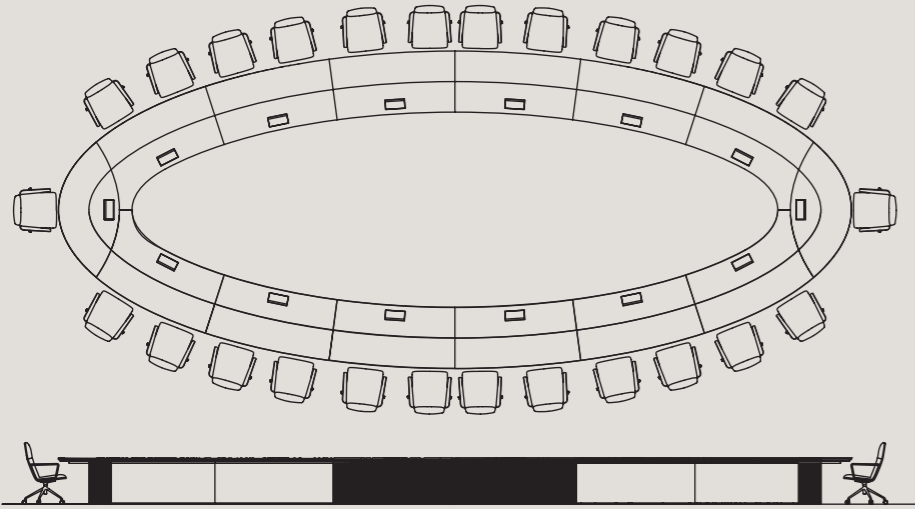

Torino

Pag 42

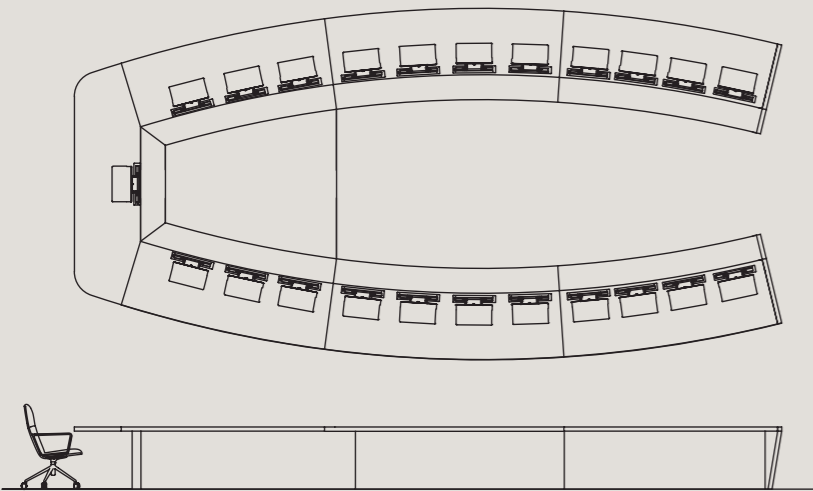

Madrid

Pag 60

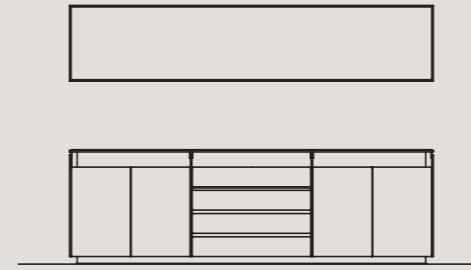
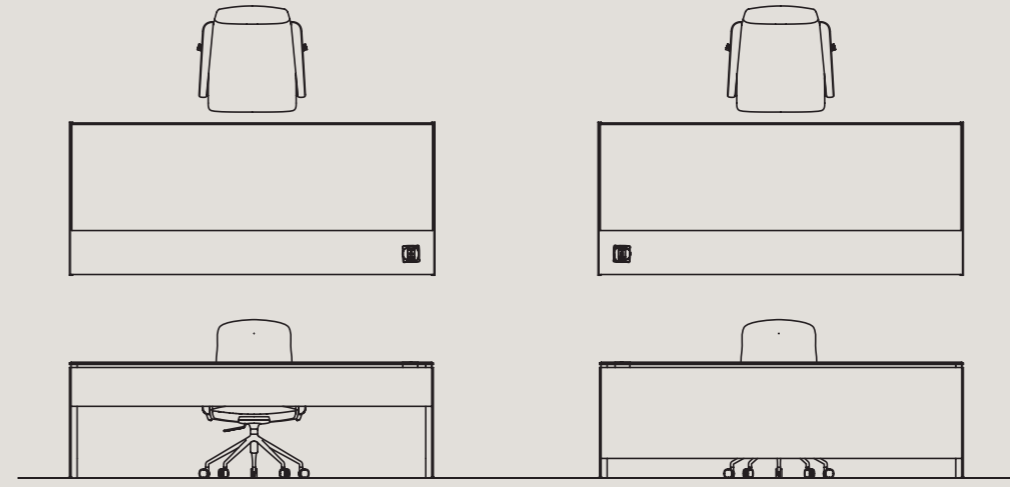

MEETING TABLE

Venecia

The Venecia meeting table has been thoughtfully designed with both functionality and aesthetics in mind. Its unique shape, inspired by the hull of a ship, not only gives it a distinctive appearance but also fosters better interaction among participants. With its oval structure, those presiding over the table can enjoy a clear, balanced view of everyone else, encouraging smooth and effective communication. This design feature makes the Venecia table perfect for meetings where visibility and connection between members are essential, helping to create a more dynamic and collaborative environment. Furthermore, its sleek and modern design brings a touch of sophistication to any workspace.

La mesa de reuniones Venecia ha sido diseñada pensando en la funcionalidad y la estética. Su forma única, inspirada en el casco de un barco, no solo le otorga un aspecto distintivo, sino que también está pensada para optimizar la interacción entre los participantes. Gracias a su estructura ovalada, quienes presiden la mesa pueden tener una visión clara y equilibrada de todos los demás, promoviendo una comunicación fluida y eficaz. Esta característica hace que la mesa Venecia sea ideal para reuniones en las que la visibilidad y la conexión entre los miembros sean clave, creando un ambiente más dinámico y colaborativo. Además, su diseño elegante y moderno aporta un toque sofisticado a cualquier espacio de trabajo.





Custom length and width.
Longitud y ancho personalizados.



Custom material choice.
Elección de material personalizada.



Flexible digital solutions.
Soluciones digitales flexibles.



Packaging = Wood + Cardboard + Edge Foam.
Embalaje = Madera + cartón + espuma.



Multiple edge choice.
Múltiples opciones de bordes.



Selection of wood grain direction.
Selección de la dirección de la veta de la madera.



Hybrid metal and wood structure.
Estructura híbrida de metal y madera.



Corporate logo option.
Opción de logotipo corporativo.



Personalised marquetry design.
Diseño de marquetería personalizado.



Removable panels or legs.
Paneles registrables o patas.



First class material.
Material de primera clase.



Quote and presentation within 24 hours.
Presupuesto y presentación en 24 horas.

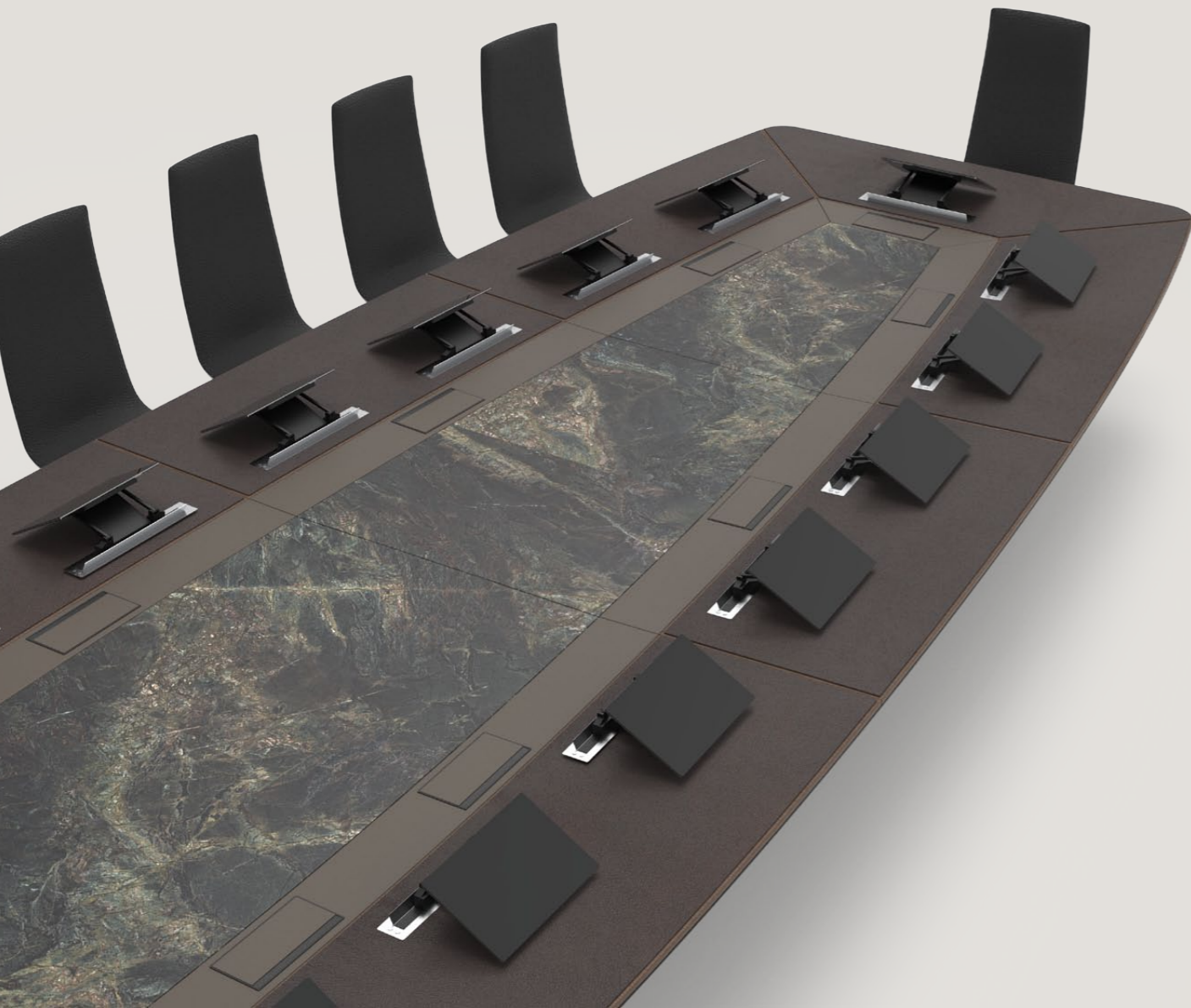



Removable panel
Hybrid metal and wood structure



Veneer
Undertop chamfer



Removable panel
Hybrid metal and wood structure

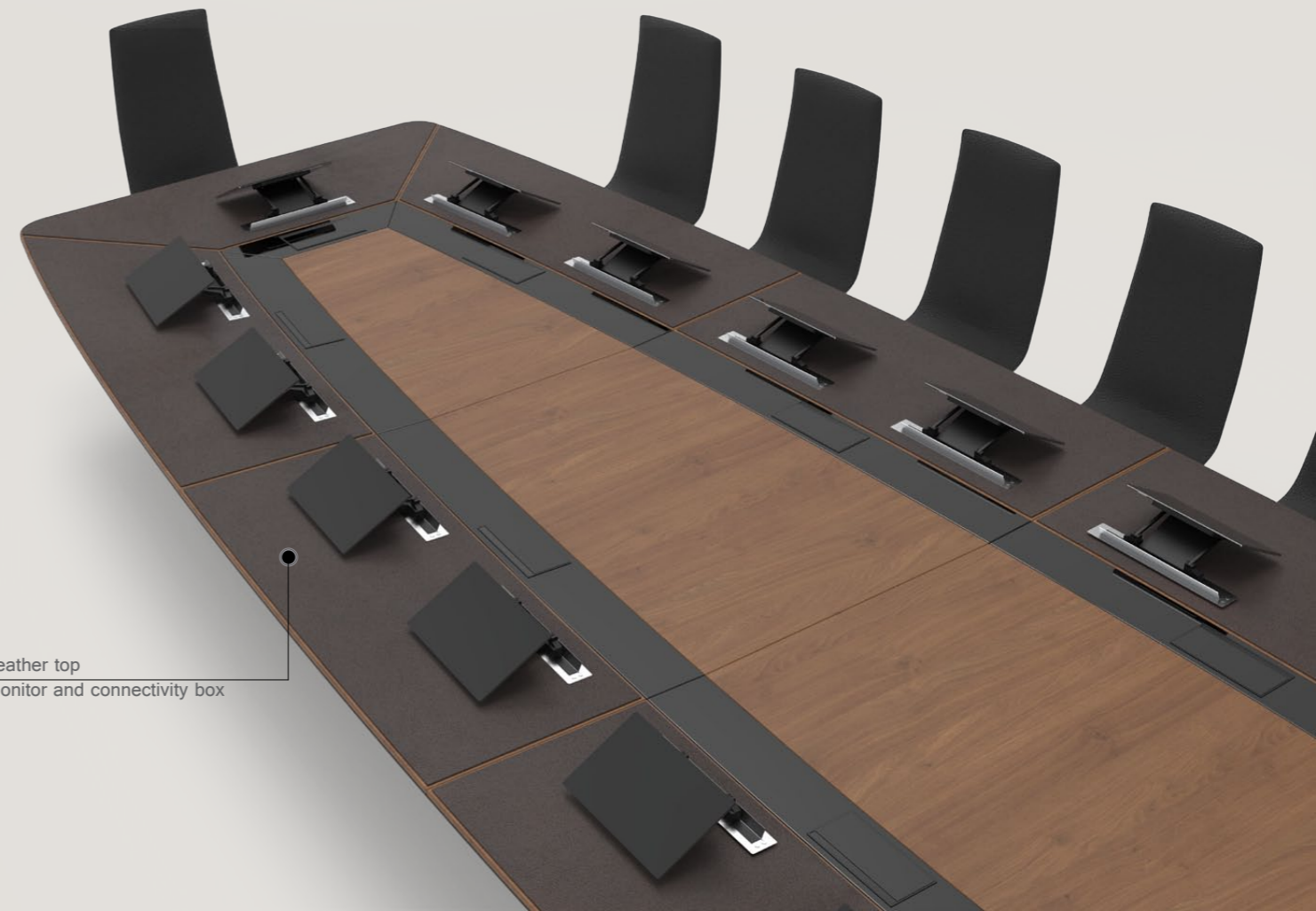

Leather top
Monitor and connectivity box



MEETING TABLE

Florence

Florence rectangular tables are the perfect choice for professional meetings and large-scale events. Their ergonomic design not only adds elegance but also optimizes space, allowing each attendee to enjoy a comfortable and functional experience. Thanks to their rectangular shape, these tables promote a clear and organized layout, ideal for encouraging idea exchange and smooth collaboration among participants.

Additionally, space utilization is maximized, ensuring that every individual has ample area to work comfortably, even during extended meetings. Their sturdy structure, combined with modern finishes, makes them a durable and stylish investment for any workspace. With Florence tables, functionality and design come together to transform any meeting into an efficient and well-organized experience.

Las mesas rectangulares Florence son la elección perfecta para reuniones profesionales y eventos de gran escala. Su diseño ergonómico no solo aporta elegancia, sino que también optimiza el espacio, permitiendo que cada asistente disfrute de una experiencia cómoda y funcional. Gracias a su forma rectangular, estas mesas promueven una disposición clara y organizada, ideal para fomentar el intercambio de ideas y la colaboración fluida entre los participantes.

Además, la distribución de los espacios se aprovecha al máximo, asegurando que cada persona disponga de suficiente área para trabajar con comodidad, incluso en reuniones prolongadas.

Su estructura robusta, combinada con acabados modernos, las convierte en una inversión duradera y estilizada para cualquier espacio de trabajo. Con las mesas Florence, la funcionalidad y el diseño se fusionan para transformar cualquier reunión en una experiencia eficiente y bien organizada.





Custom length and width.
Longitud y ancho personalizados.



Custom material choice.
Elección de material personalizada.



Flexible digital solutions.
Soluciones digitales flexibles.



Packaging = Wood + Cardboard + Edge Foam.
Embalaje = Madera + cartón + espuma.



Multiple edge choice.
Múltiples opciones de bordes.



Selection of wood grain direction.
Selección de la dirección de la veta de la madera.



Hybrid metal and wood structure.
Estructura híbrida de metal y madera.



Corporate logo option.
Opción de logotipo corporativo.



Personalised marquetry design.
Diseño de marquetería personalizado.



Removable panels or legs.
Paneles registrables o patas.



First class material.
Material de primera clase.



Quote and presentation within 24 hours.
Presupuesto y presentación en 24 horas.

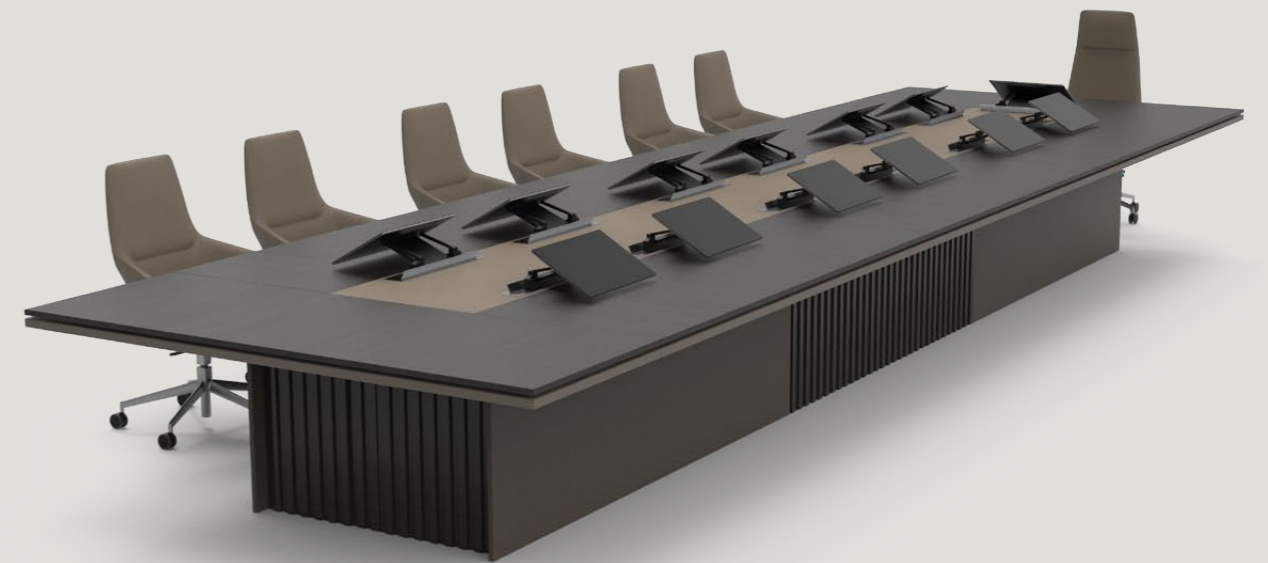
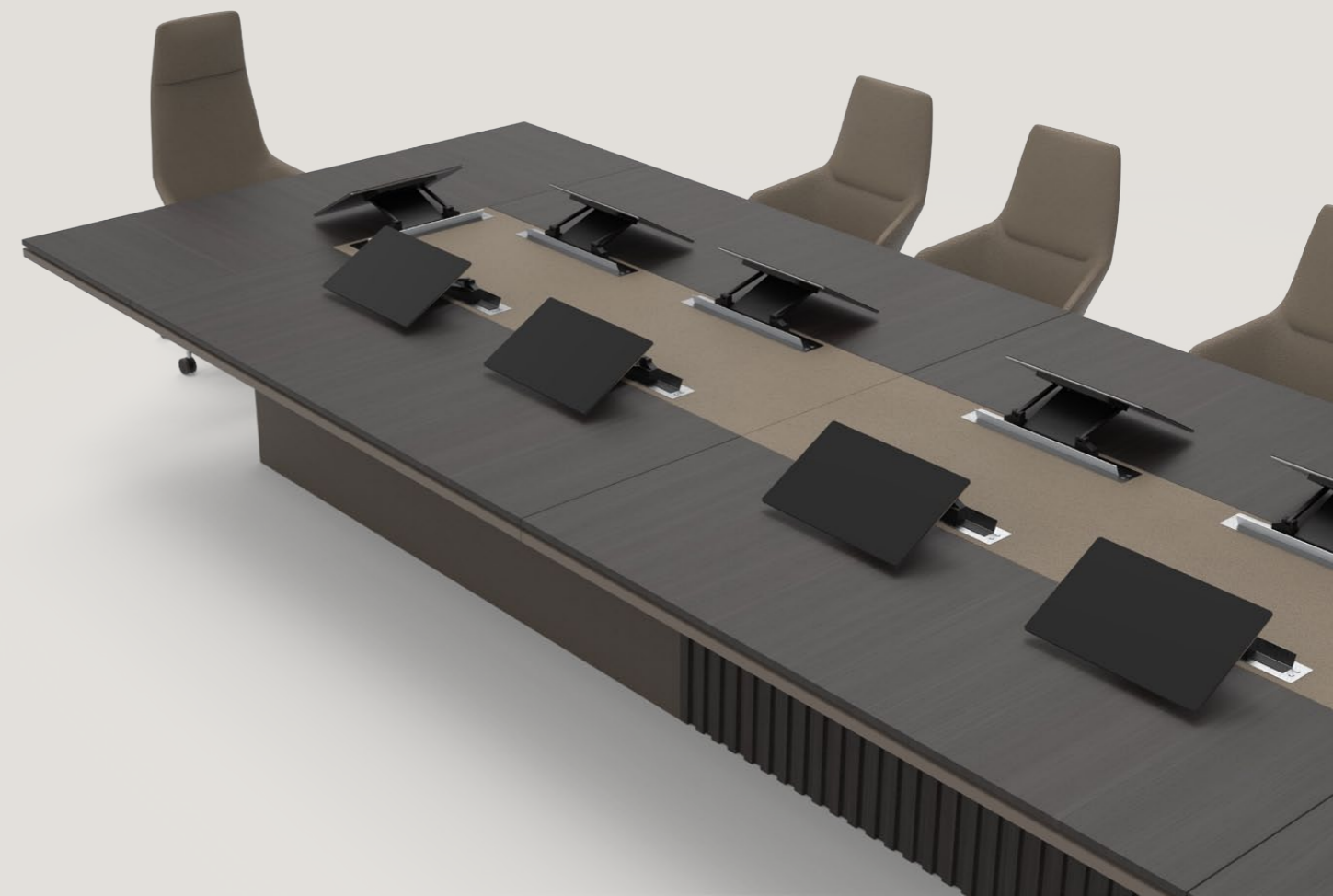



Removable panel
Hybrid metal and wood structure

Double edge



Veneer
Undertop lacquered



BESPOKE

Removable panel
Hybrid metal and wood structure



Natural marble 20 mm
Connectivity Box (Top Marble)



MEETING TABLE

Torino

The Torino meeting table is a true masterpiece of furniture design—unique, fully customizable, and crafted to meet the specific needs of every client. Its innovative structure not only excels in functionality but also positions it as an exceptional choice for high-level professional meetings. Available in an exquisite range of materials, including leather, wood, marble, metals, and premium lacquers, the Torino table seamlessly adapts to the style and character of any space. Furthermore, the option to engrave a company logo on its surface adds an exclusive and distinctive touch, making it ideal for luxury environments and corporate offices.

La mesa de reuniones Torino es una obra maestra del mobiliario, única y completamente personalizable, diseñada para satisfacer las necesidades específicas de cada cliente. Su estructura innovadora no solo destaca por su funcionalidad, sino que también la convierte en una opción excepcional para reuniones profesionales de alto nivel.

Disponible en una exquisita selección de materiales, como piel, madera, mármol, metales y lacados de alta calidad, la mesa Torino se adapta perfectamente al estilo y la personalidad de cualquier espacio. Además, la opción de grabar el logotipo de la empresa sobre la superficie le confiere un carácter exclusivo y distintivo, ideal para entornos de lujo y oficinas corporativas.





Custom length and width.
Longitud y ancho personalizados.



Hybrid metal and wood structure.
Estructura híbrida de metal y madera.



Custom material choice.
Elección de material personalizada.



Corporate logo option.
Opción de logotipo corporativo.



Flexible digital solutions.
Soluciones digitales flexibles.



Personalised marquetry design.
Diseño de marquetería personalizado.



Packaging = Wood + Cardboard + Edge Foam.
Embalaje = Madera + cartón + espuma.



Removable panels or legs.
Paneles registrables o patas.



Multiple edge choice.
Múltiples opciones de bordes.



First class material.
Material de primera clase.



Selection of wood grain direction.
Selección de la dirección de la veta de la madera.



Quote and presentation within 24 hours.
Presupuesto y presentación en 24 horas.



Removable panel
Hybrid metal and wood structure



BESPOKE

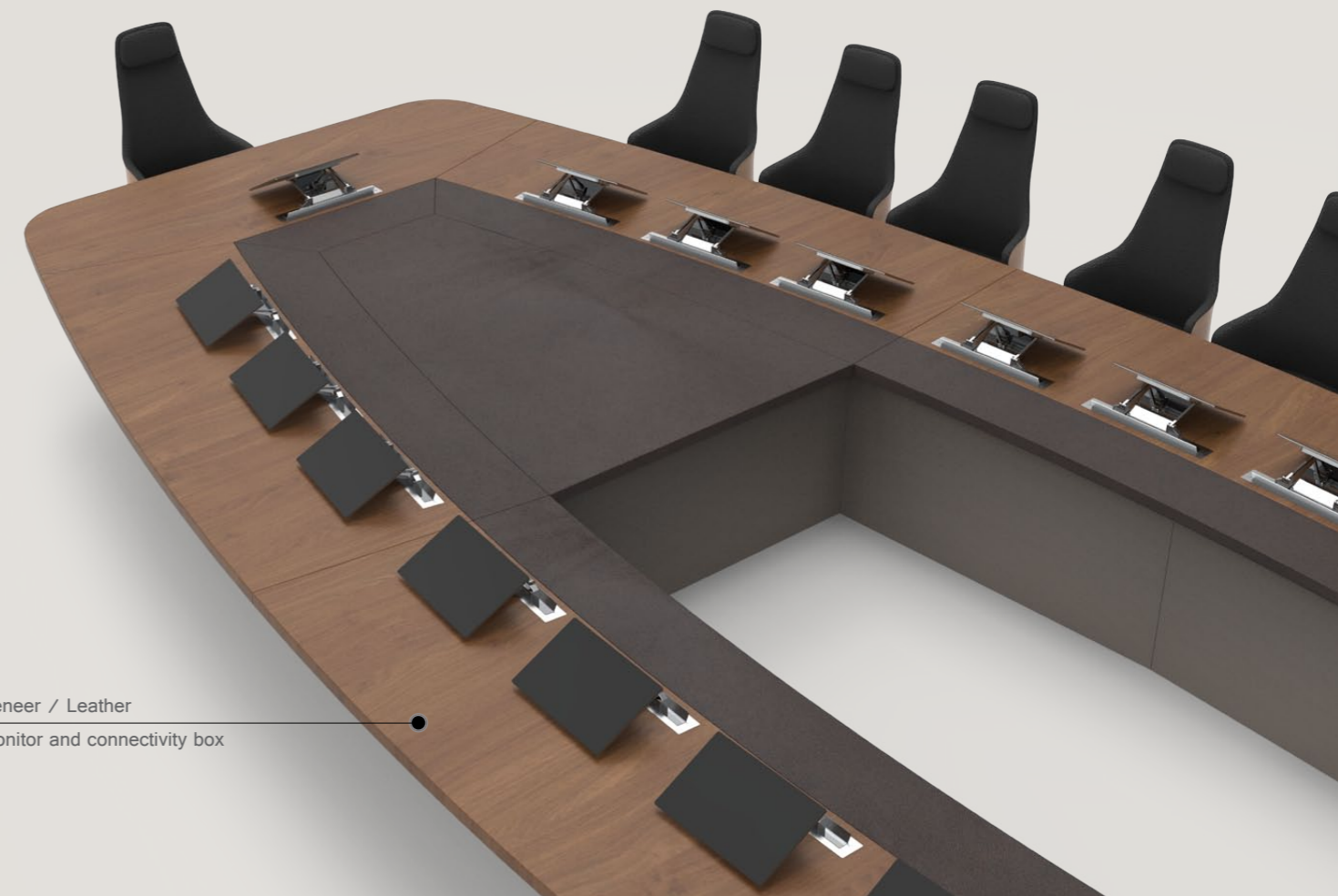

Veneer / Leather
Monitor and connectivity box



MEETING TABLE

Coliseo

The Coliseo meeting table is a unique and highly versatile solution, designed to seamlessly fit any office space and cater to the specific needs of each client. Its oval shape not only offers an elegant and contemporary aesthetic, but also fosters enhanced interaction among participants by allowing everyone to see each other's faces clearly and quickly, creating a more collaborative and efficient atmosphere.

This model is fully customizable in both size and materials, enabling clients to design a table that perfectly aligns with their requirements. Furthermore, the Coliseo table can be equipped with cutting-edge technology such as monitors, USB ports, power outlets, or wireless chargers, transforming it into a multifunctional tool that enhances connectivity and streamlines the use of devices during meetings.

La mesa de reuniones Coliseo es una opción única y versátil, diseñada para adaptarse a cualquier tipo de espacio de oficina y a las necesidades de cada cliente. Su forma ovalada no solo proporciona una estética elegante y moderna, sino que también fomenta una mejor interacción entre los participantes, ya que permite que todos puedan verse las caras rápidamente durante las reuniones, creando un ambiente más colaborativo y eficiente.

Este modelo se puede personalizar tanto en tamaño como en materiales, lo que permite que cada cliente cree la mesa que mejor se ajuste a sus requerimientos.

Además, la mesa Coliseo ofrece la posibilidad de integrar tecnología avanzada, como monitores, puertos USB, enchufes o cargadores inalámbricos, convirtiéndola en una herramienta multifuncional que facilita la conectividad y el uso de dispositivos durante las reuniones.





Custom length and width.
Longitud y ancho personalizados.



Hybrid metal and wood structure.
Estructura híbrida de metal y madera.



Custom material choice.
Elección de material personalizada.



Corporate logo option.
Opción de logotipo corporativo.



Flexible digital solutions.
Soluciones digitales flexibles.



Personalised marquetry design.
Diseño de marquetería personalizado.



Packaging = Wood + Cardboard + Edge Foam.
Embalaje = Madera + cartón + espuma.



Removable panels or legs.
Paneles registrables o patas.



Multiple edge choice.
Múltiples opciones de bordes.



First class material.
Material de primera clase.



Selection of wood grain direction.
Selección de la dirección de la veta de la madera.



Quote and presentation within 24 hours.
Presupuesto y presentación en 24 horas.

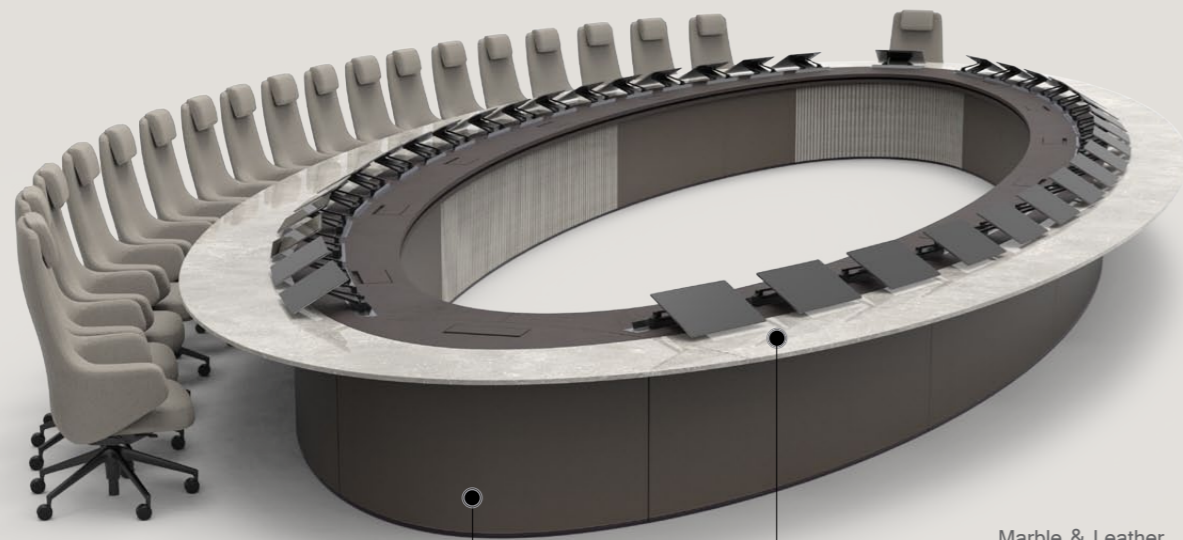

Removable panel
Hybrid metal and wood structure

Marble & Leather
Monitor and connectivity box

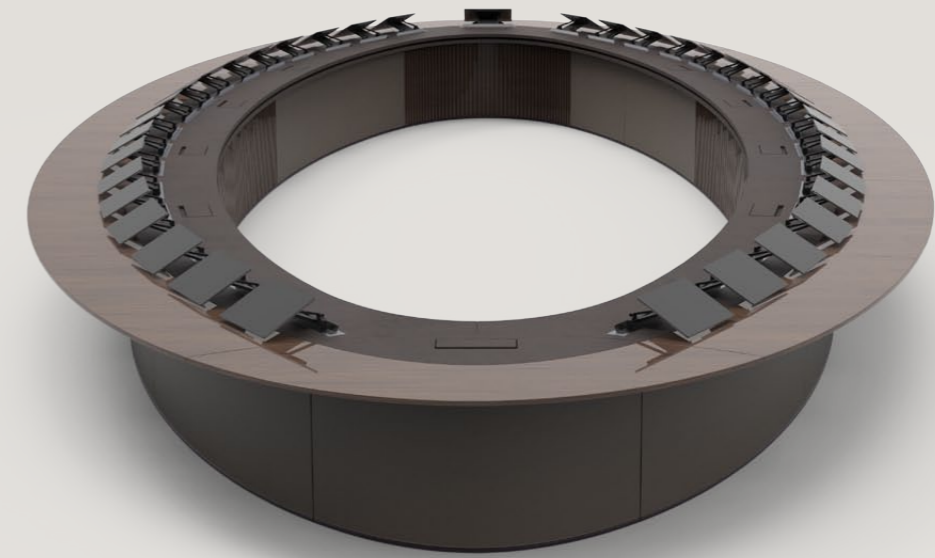

BESPOKE

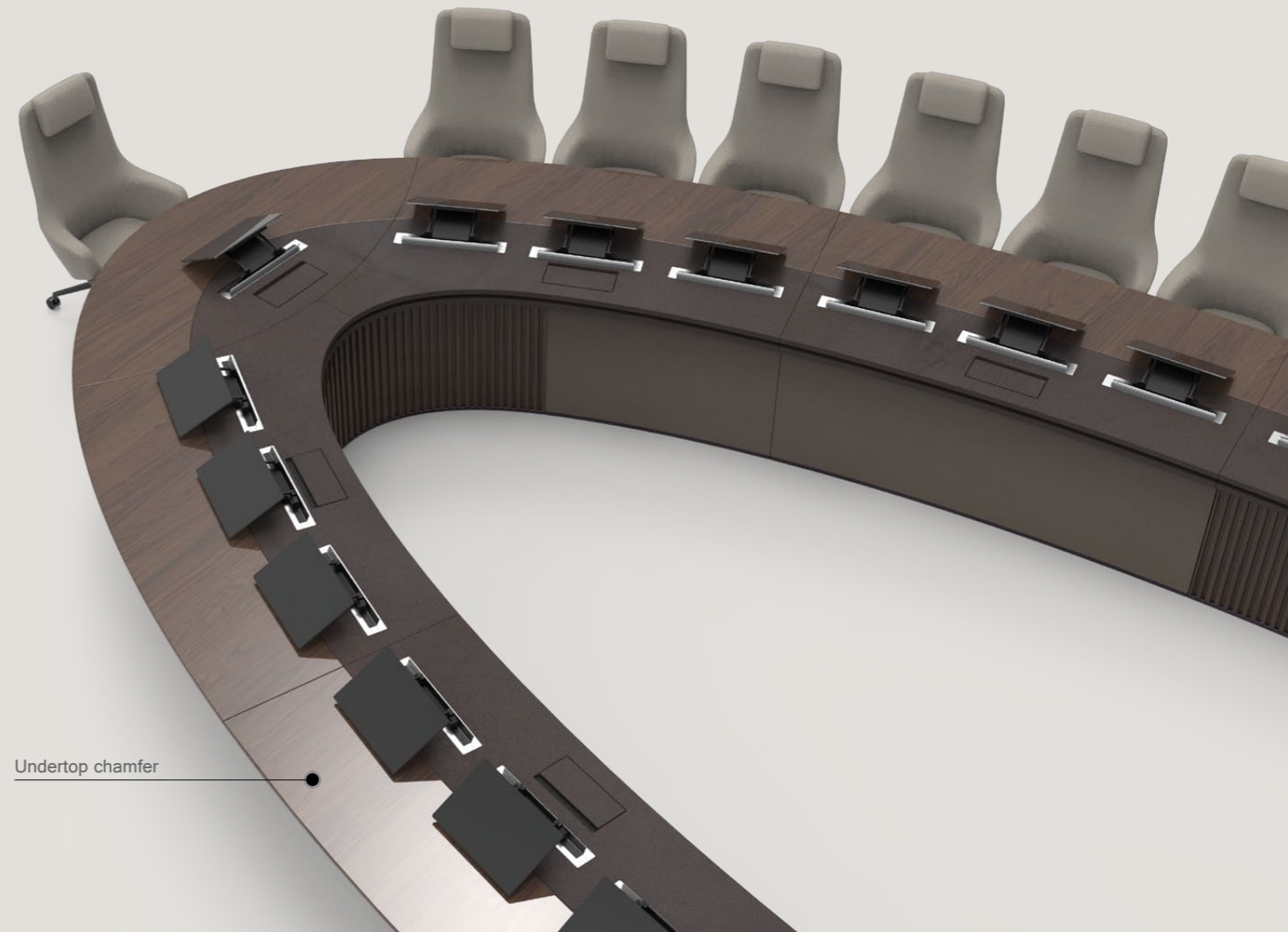

Undertop chamfer



DESKS

Madrid

The Madrid desk is distinguished by its visual lightness, featuring an exterior surface of just 1 cm thickness, internally reinforced with a sturdier frame to ensure the required rigidity and durability. Its minimalist and elegant design makes it the ideal choice for any modern workspace, offering a contemporary aesthetic without compromising functionality.

This model is complemented by a customizable auxiliary unit, providing flexible storage solutions that can be tailored to meet the specific needs of any office, enabling efficient organization of office materials and accessories.

Furthermore, the Madrid desk is designed to integrate advanced technology, such as connection boxes, power outlets, USB ports, and a cable management tray, helping to maintain a clean and organized space free of visible cables.

El escritorio Madrid se distingue por su ligereza visual, gracias a su tablero exterior de solo 1 cm de espesor, reforzado internamente con un bastidor de mayor grosor que garantiza la rigidez y durabilidad necesarias. Su diseño minimalista y elegante lo convierte en la opción perfecta para cualquier espacio de trabajo moderno, ofreciendo una estética contemporánea sin sacrificar la funcionalidad. Este modelo se complementa con un mueble auxiliar personalizable, que proporciona soluciones de almacenamiento adaptables a las necesidades de cada oficina, permitiendo organizar de manera eficiente todos los materiales y accesorios de trabajo. Además, el escritorio Madrid está diseñado para integrar tecnología avanzada, como cajas de conexión, enchufes, puertos USB y una bandeja pasacables, lo que contribuye a mantener el espacio ordenado y libre de cables visibles.

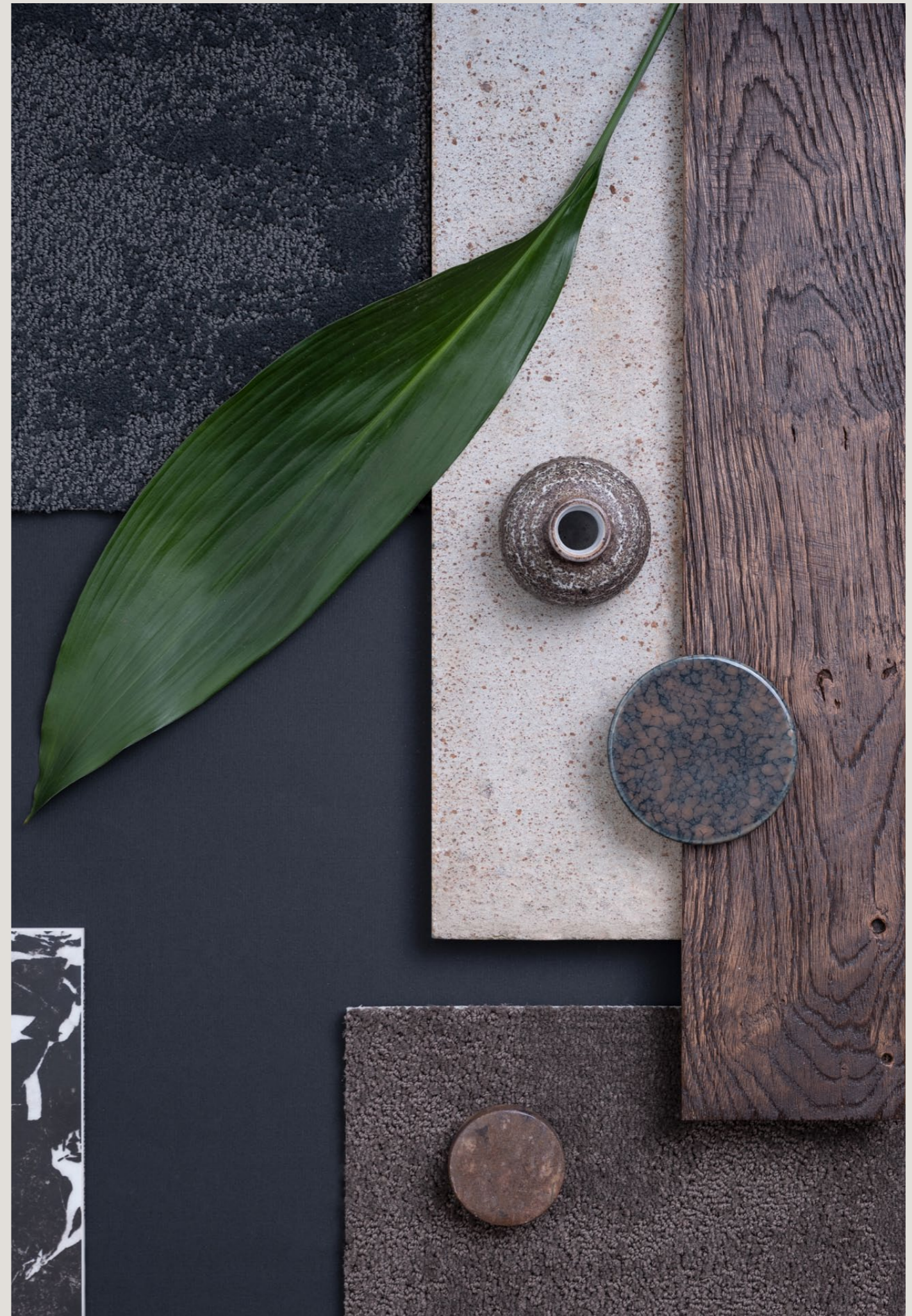



Custom length and width.
Longitud y ancho personalizados.



Adjustable height desk.
Escritorio ajustable en altura.



Custom material choice.
Elección de material personalizada.



Corporate logo option.
Opción de logotipo corporativo.



Flexible digital solutions.
Soluciones digitales flexibles.



Personalised marquetry design.
Diseño de marquetería personalizado.



Packaging = Wood + Cardboard + Edge Foam.
Embalaje = Madera + cartón + espuma.



Modesty panel (Optional)
Panel de privacidad (Opcional)



Multiple edge choice.
Múltiples opciones de bordes.



First class material.
Material de primera clase.



Selection of wood grain direction.
Selección de la dirección de la veta de la madera.



Quote and presentation within 24 hours.
Presupuesto y presentación en 24 horas.

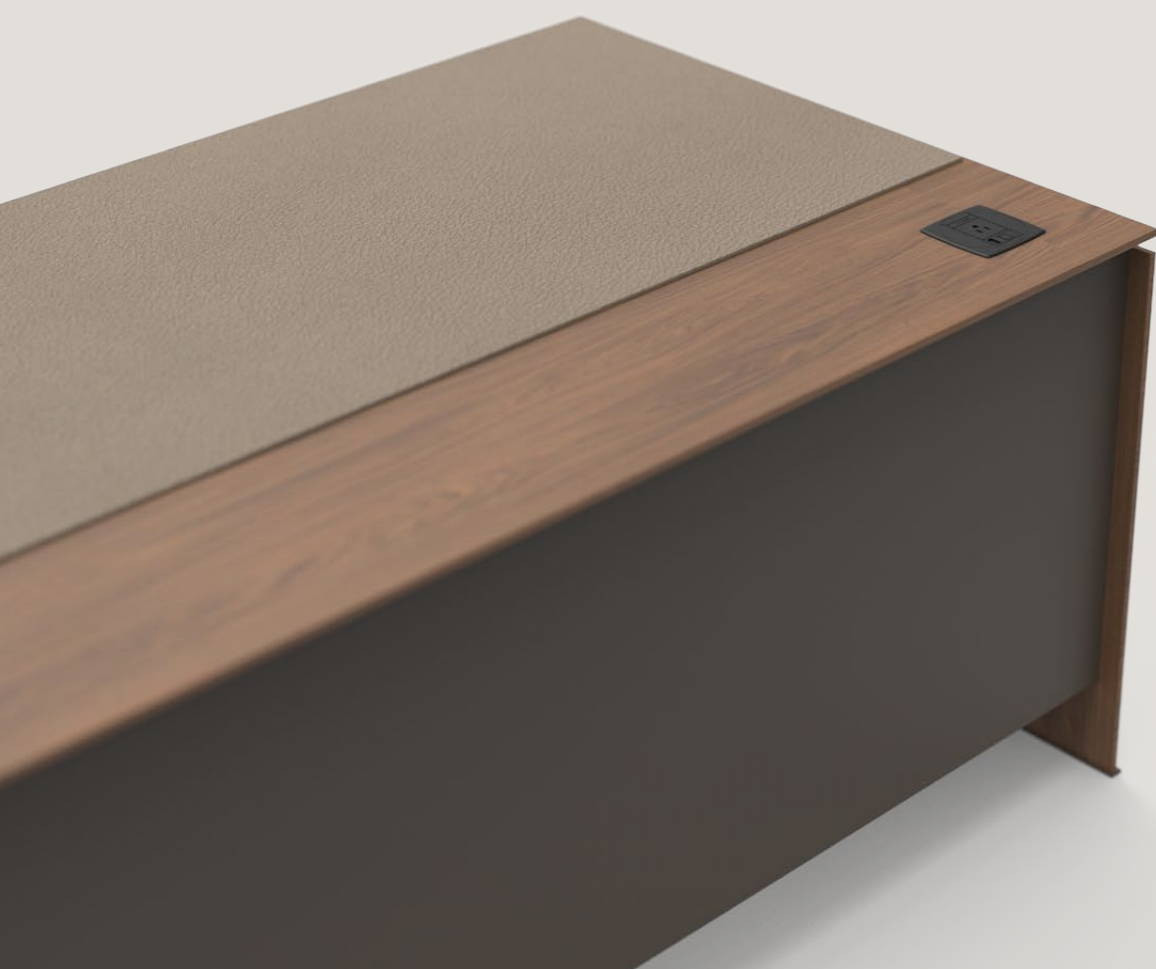

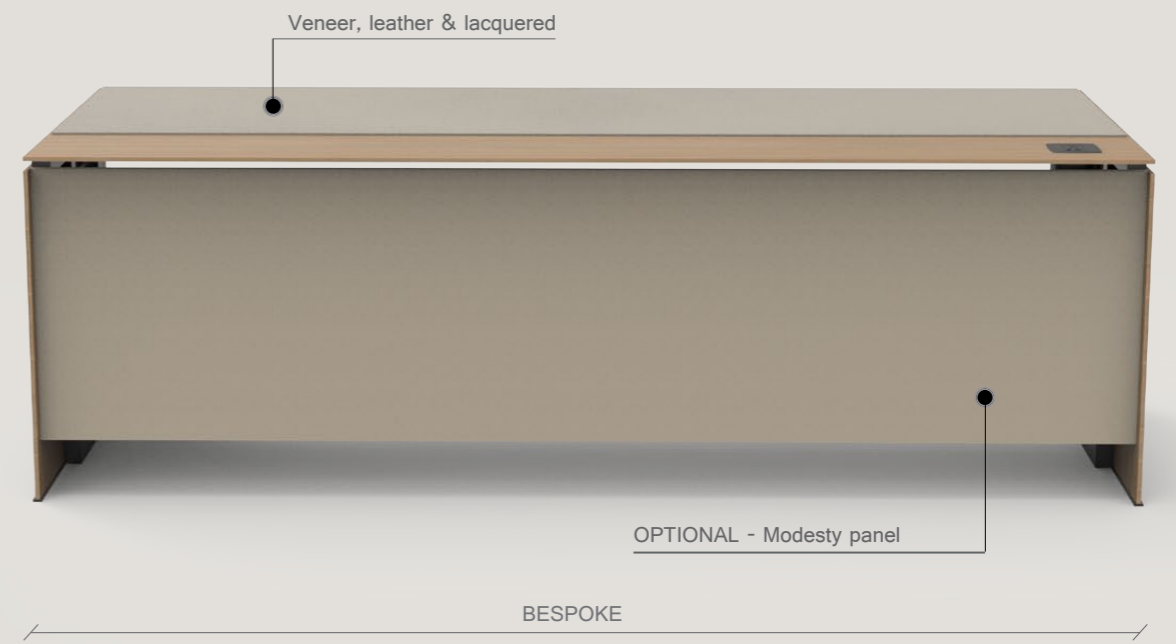
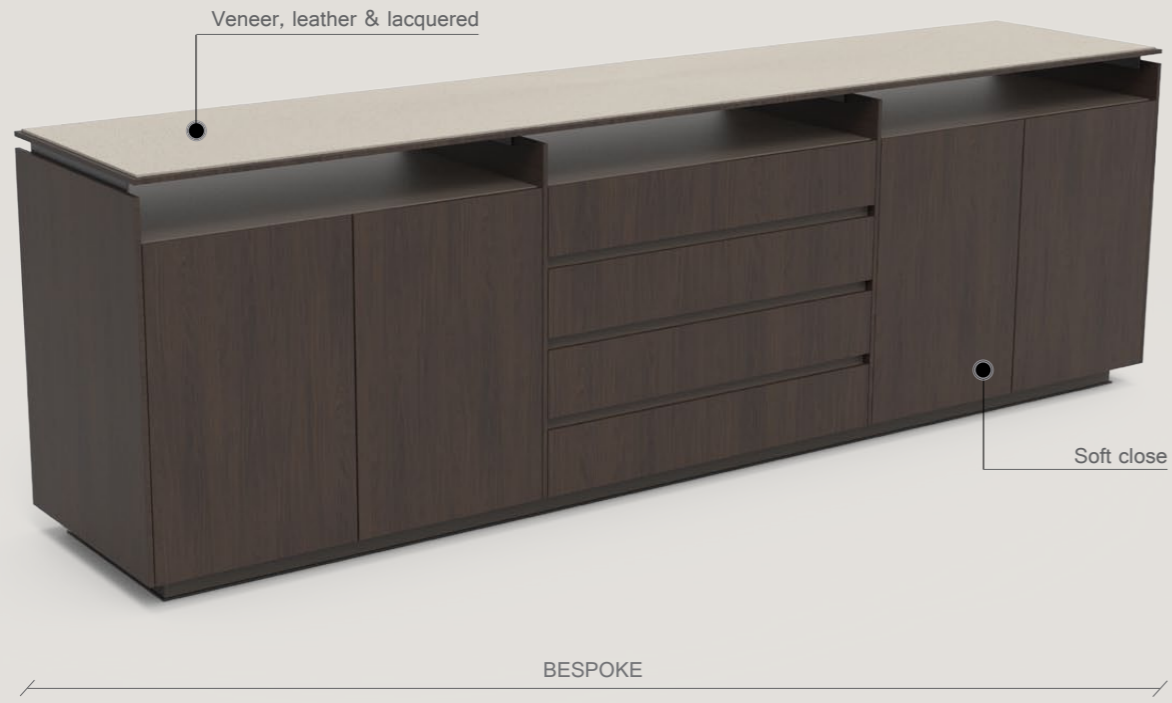



DESKS

Barcelona

The Barcelona desk is not just a piece of furniture; it is a statement of style and distinction. Its impeccable design and striking visual presence make it a centerpiece in any executive or workspace. Every line has been carefully crafted to convey exclusivity and sophistication.

The fully beveled and mitered edges enhance its avant-garde aesthetic, creating a sense of fluidity and dynamism. The Barcelona can be fully customized, crafted from a wide selection of fine woods and premium leathers, ensuring finishes that meet the highest standards of elegance and personal taste.

More than just a desk, the Barcelona is a functional work of art, designed for those who appreciate excellence in every detail. Its presence in any space not only reflects refined taste but also a commitment to uncompromising design.

El escritorio Barcelona no es solo un mueble; es una declaración de estilo y distinción. Su diseño impecable y su carga visual impactante lo convierten en una pieza central en cualquier entorno de trabajo o dirección. Cada línea ha sido cuidadosamente concebida para transmitir exclusividad y sofisticación. Los cantos totalmente biselados e ingletados refuerzan su estética vanguardista, aportando una sensación de fluidez y dinamismo. La fabricación del Barcelona permite una personalización absoluta, pudiendo realizarse en una amplia variedad de maderas nobles y pieles selectas, logrando acabados que se adaptan a los gustos más exigentes. Más que un escritorio, el Barcelona es una obra de arte funcional, diseñado para quienes valoran la excelencia en cada detalle. Su presencia en un espacio no solo refleja buen gusto, sino también una apuesta por el diseño sin concesiones.

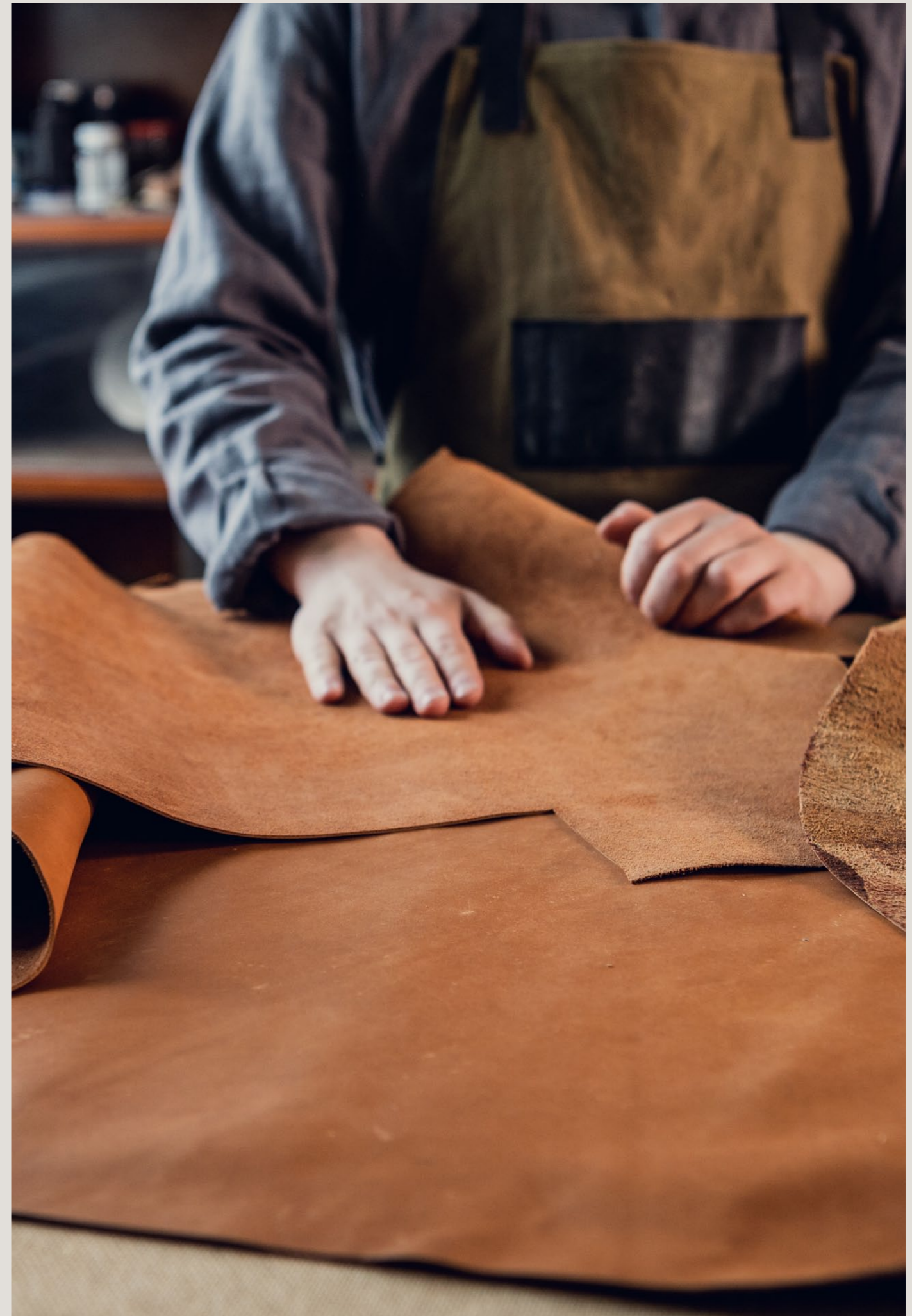



Custom length and width.
Longitud y ancho personalizados.



Adjustable height desk.
Escritorio ajustable en altura.



Custom material choice.
Elección de material personalizada.



Corporate logo option.
Opción de logotipo corporativo.



Flexible digital solutions.
Soluciones digitales flexibles.



Personalised marquetry design.
Diseño de marquetería personalizado.



Packaging = Wood + Cardboard + Edge Foam.
Embalaje = Madera + cartón + espuma.



Modesty panel (Optional)
Panel de privacidad (Opcional)



Multiple edge choice.
Múltiples opciones de bordes.



First class material.
Material de primera clase.



Selection of wood grain direction.
Selección de la dirección de la veta de la madera.



Quote and presentation within 24 hours.
Presupuesto y presentación en 24 horas.



BESPOKE



MEETING TABLE

Rome

The Rome meeting table is thoughtfully designed with both functionality and aesthetics in mind. Its unique shape, inspired by the hull of a ship, not only gives it a distinctive appearance but is also crafted to enhance interaction among participants. With its oval structure, those at the head of the table enjoy a clear and balanced view of everyone else, fostering smooth and effective communication. This design feature makes the Rome table ideal for meetings where visibility and connectivity between members are essential, creating a more dynamic and collaborative environment. Additionally, its sleek and modern design adds a sophisticated touch to any workspace.

La mesa de reuniones Rome ha sido diseñada pensando en la funcionalidad y la estética. Su forma única, inspirada en el casco de un barco, no solo le otorga un aspecto distintivo, sino que también está pensada para optimizar la interacción entre los participantes. Gracias a su estructura ovalada, quienes presiden la mesa pueden tener una visión clara y equilibrada de todos los demás, promoviendo una comunicación fluida y eficaz. Esta característica hace que la mesa Rome sea ideal para reuniones en las que la visibilidad y la conexión entre los miembros sean clave, creando un ambiente más dinámico y colaborativo. Además, su diseño elegante y moderno aporta un toque sofisticado a cualquier espacio de trabajo.





Custom length and width.
Longitud y ancho personalizados.



Custom material choice.
Elección de material personalizada.



Flexible digital solutions.
Soluciones digitales flexibles.



Packaging = Wood + Cardboard + Edge Foam.
Embalaje = Madera + cartón + espuma.



Multiple edge choice.
Múltiples opciones de bordes.



Selection of wood grain direction.
Selección de la dirección de la veta de la madera.



Hybrid metal and wood structure.
Estructura híbrida de metal y madera.



Corporate logo option.
Opción de logotipo corporativo.



Personalised marquetry design.
Diseño de marquetería personalizado.



Removable panels or legs.
Paneles registrables o patas.



First class material.
Material de primera clase.



Quote and presentation within 24 hours.
Presupuesto y presentación en 24 horas.

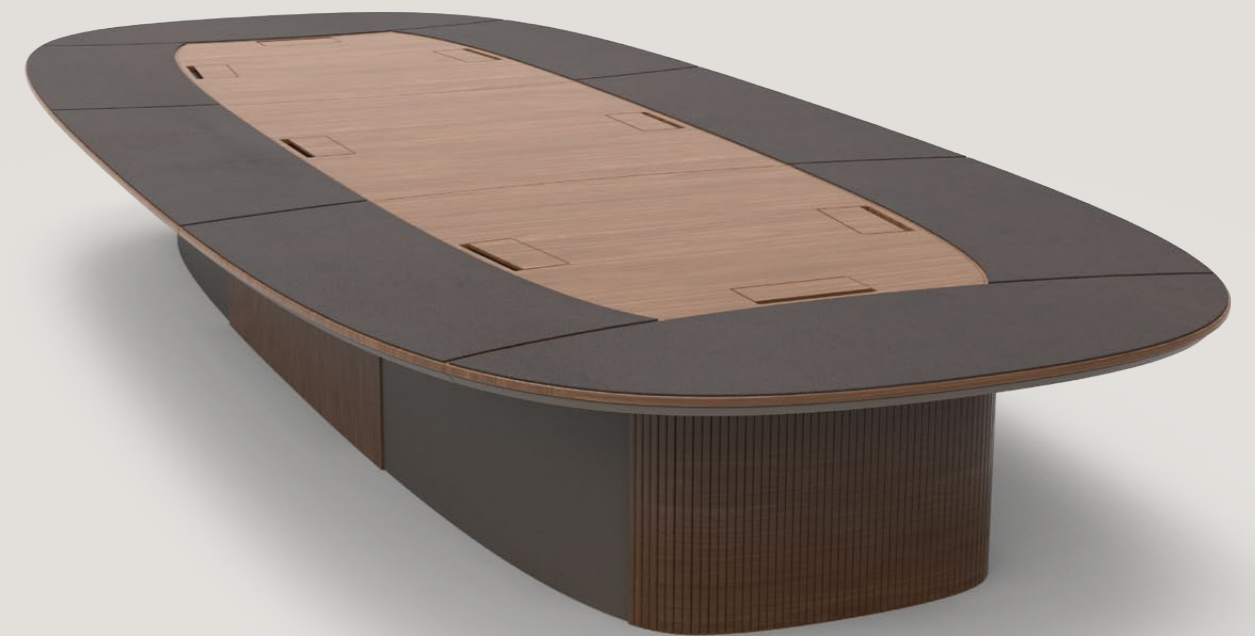
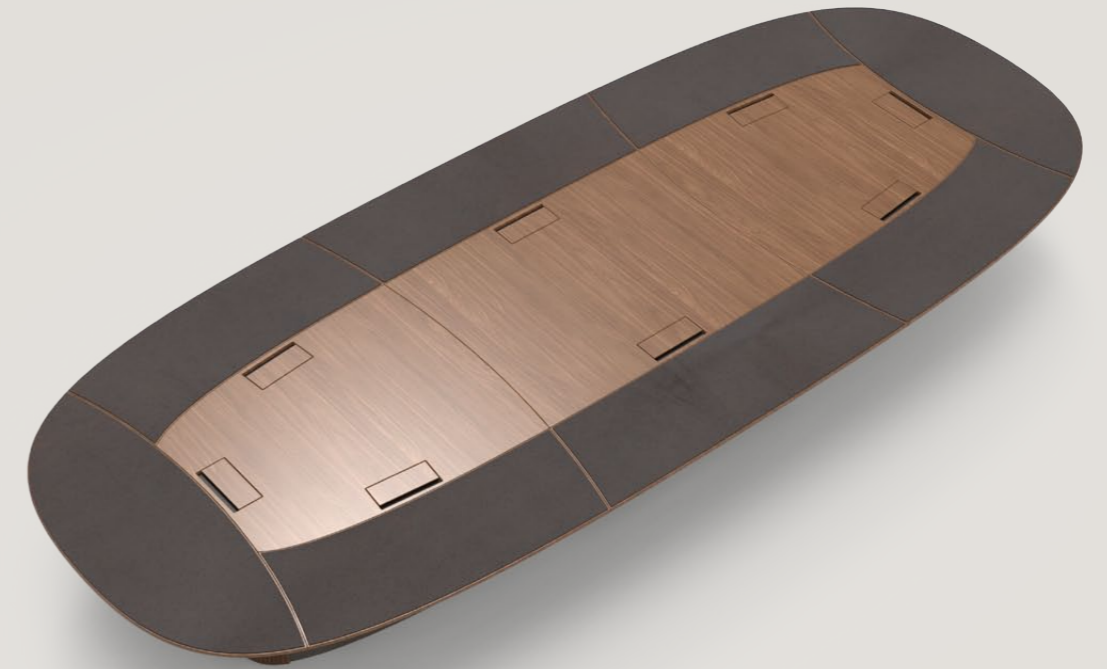



Removable panel
Hybrid metal and wood structure

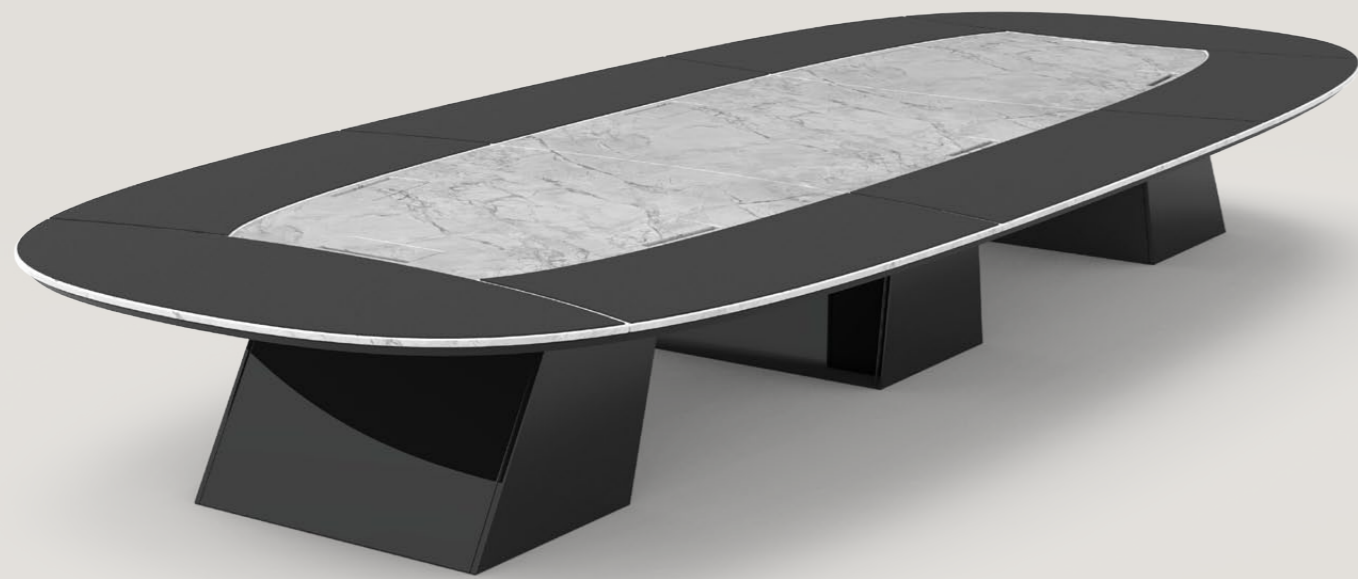

BESPOKE



Bespoke design



Veneer / Leather
Undertop chamfer



MEETING TABLE

Coppola

The Coppola meeting table is an elegant and highly functional solution, designed to offer versatility and adaptability for any workspace. Featuring a circular structure, its diameter and materials are fully customizable, allowing for the creation of a unique table that perfectly suits the needs and style of each office or meeting room. Thanks to its design, the Coppola table enables seamless interaction among participants, as its round shape allows everyone to see and communicate with each other easily and quickly. This makes it an ideal choice for collaborative work meetings, where open communication and cooperation are essential. Additionally, the table offers the option of curved or faceted panels, adding a distinctive and personalized touch to the design, depending on the desired style.

La mesa de reuniones Coppola es una opción elegante y funcional, diseñada para ofrecer versatilidad y adaptabilidad a cualquier espacio de trabajo. Con una estructura circular, su diámetro y materiales son totalmente personalizables, lo que permite crear una mesa única que se ajuste perfectamente a las necesidades y estilo de cada oficina o sala de reuniones.

Gracias a su diseño, la mesa Coppola facilita una interacción fluida entre los participantes, ya que su forma circular permite que todos los asistentes puedan verse y comunicarse de manera cómoda y rápida. Este detalle la convierte en una opción ideal para reuniones de trabajo colaborativas, donde la comunicación abierta y la cooperación son clave. Además, la mesa ofrece la opción de paneles curvos o facetados, lo que añade un toque distintivo y personalizado a la mesa, según el diseño elegido.





Custom length and width.
Longitud y ancho personalizados.



Hybrid metal and wood structure.
Estructura híbrida de metal y madera.



Custom material choice.
Elección de material personalizada.



Corporate logo option.
Opción de logotipo corporativo.



Flexible digital solutions.
Soluciones digitales flexibles.



Personalised marquetry design.
Diseño de marquetería personalizado.



Packaging = Wood + Cardboard + Edge Foam.
Embalaje = Madera + cartón + espuma.



Removable panels or legs.
Paneles registrables o patas.



Multiple edge choice.
Múltiples opciones de bordes.



First class material.
Material de primera clase.



Selection of wood grain direction.
Selección de la dirección de la veta de la madera.



Quote and presentation within 24 hours.
Presupuesto y presentación en 24 horas.

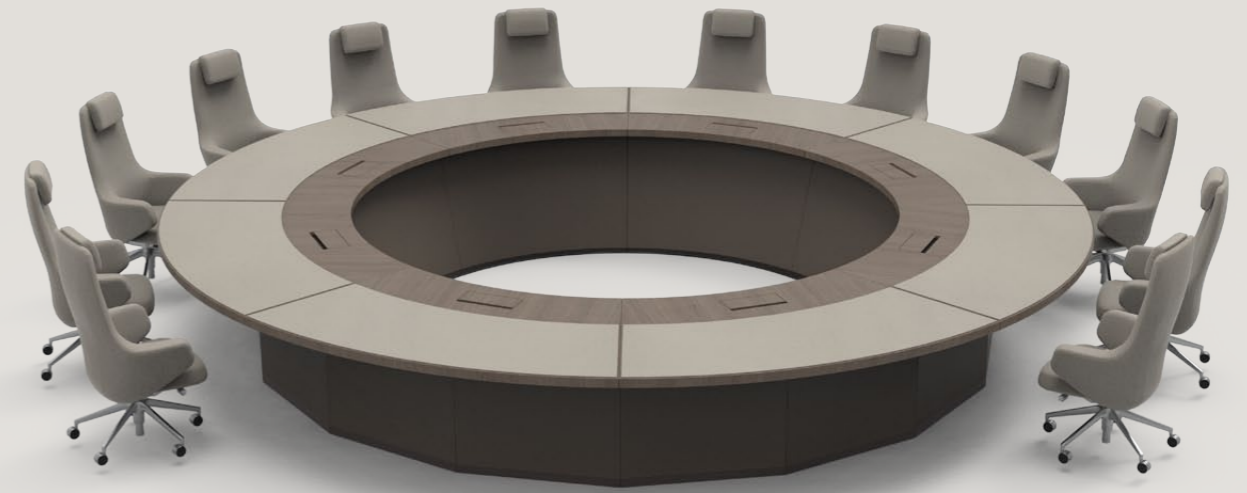

BESPOKE

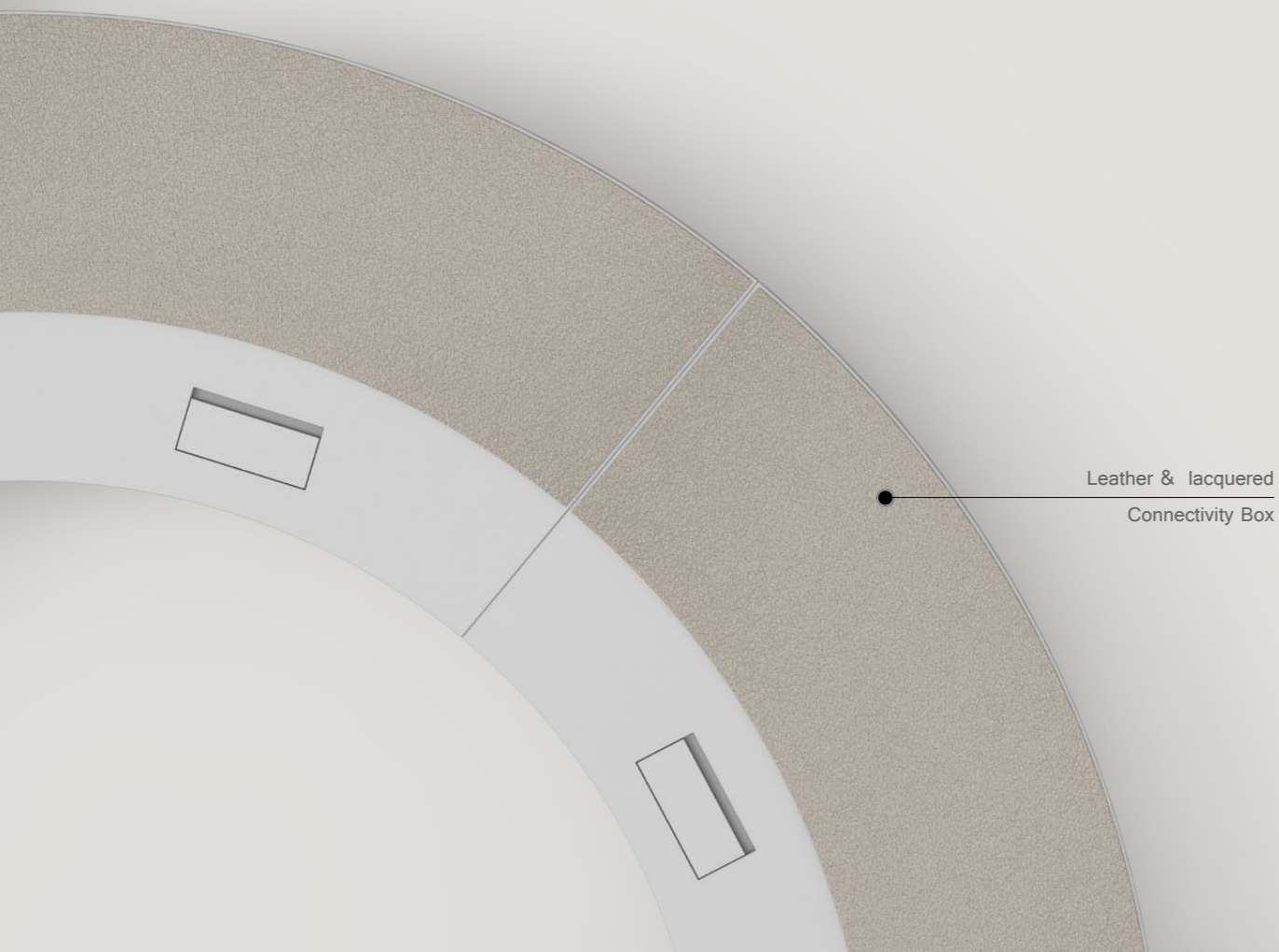

Leather & lacquered
Connectivity Box

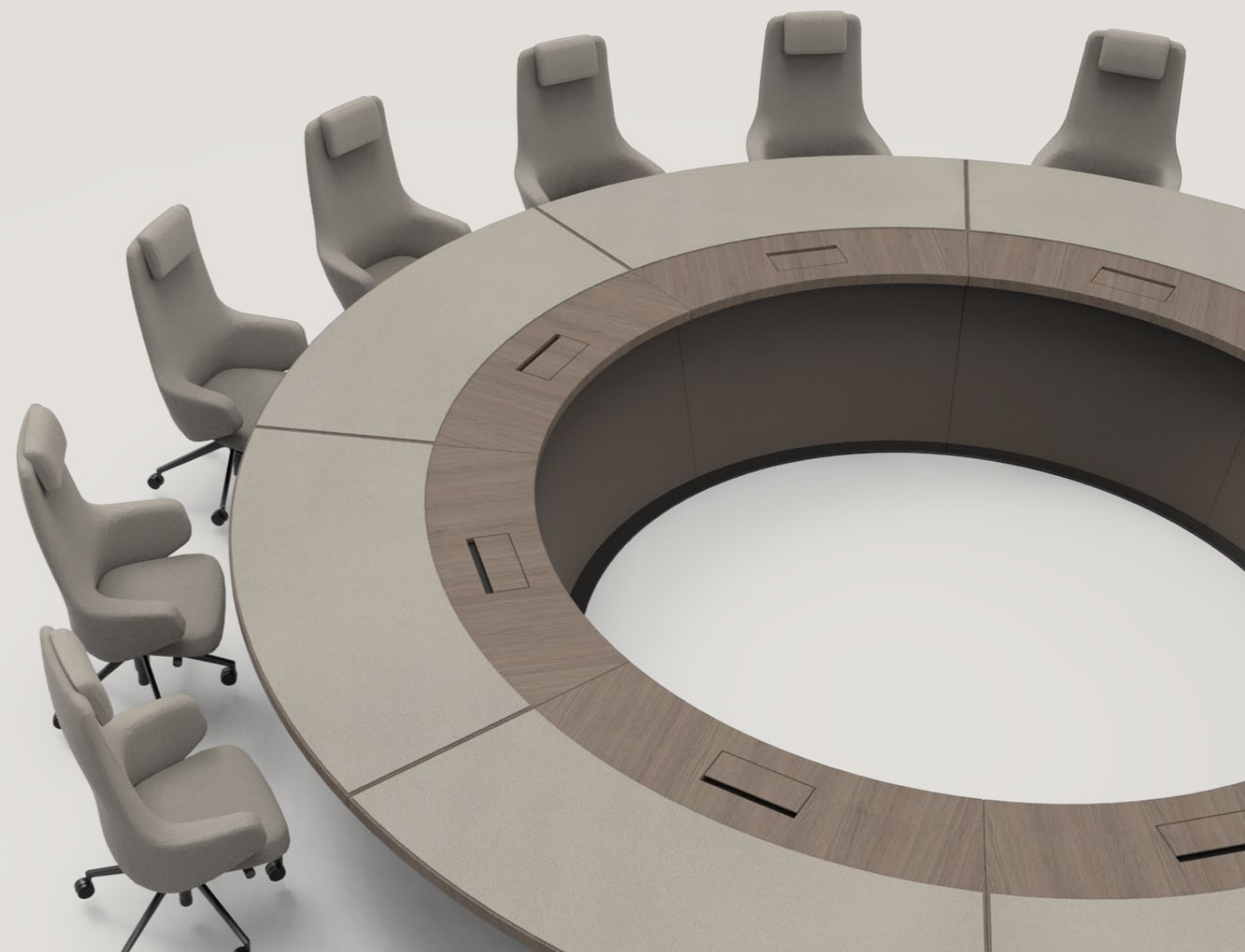



MEETING TABLE

Fontana

The Fontana meeting table is an elegant and highly functional solution, designed to offer versatility and adaptability for any workspace. Featuring a circular structure, its diameter and materials are fully customizable, allowing for the creation of a unique table that perfectly suits the needs and style of each office or meeting room.

Thanks to its design, the Fontana table enables seamless interaction among participants, as its round shape allows everyone to see and communicate with each other easily and quickly. This makes it an ideal choice for collaborative work meetings, where open communication and cooperation are essential.

Additionally, the table offers the option of curved or faceted panels, adding a distinctive and personalized touch to the design, depending on the desired style.

La mesa de reuniones Fontana es una opción elegante y funcional, diseñada para ofrecer versatilidad y adaptabilidad a cualquier espacio de trabajo. Con una estructura circular, su diámetro y materiales son totalmente personalizables, lo que permite crear una mesa única que se ajuste perfectamente a las necesidades y estilo de cada oficina o sala de reuniones.

Gracias a su diseño, la mesa Fontana facilita una interacción fluida entre los participantes, ya que su forma circular permite que todos los asistentes puedan verse y comunicarse de manera cómoda y rápida. Este detalle la convierte en una opción ideal para reuniones de trabajo colaborativas, donde la comunicación abierta y la cooperación son clave.

Además, la mesa ofrece la opción de paneles curvos o facetados, lo que añade un toque distintivo y personalizado a la mesa, según el diseño elegido.





Custom length and width.
Longitud y ancho personalizados.



Custom material choice.
Elección de material personalizada.



Flexible digital solutions.
Soluciones digitales flexibles.



Packaging = Wood + Cardboard + Edge Foam.
Embalaje = Madera + cartón + espuma.



Multiple edge choice.
Múltiples opciones de bordes.



Selection of wood grain direction.
Selección de la dirección de la veta de la madera.



Hybrid metal and wood structure.
Estructura híbrida de metal y madera.



Corporate logo option.
Opción de logotipo corporativo.



Personalised marquetry design.
Diseño de marquetería personalizado.



Removable panels or legs.
Paneles registrables o patas.



First class material.
Material de primera clase.



Quote and presentation within 24 hours.
Presupuesto y presentación en 24 horas.





MEETING TABLE

Verona

The Verona meeting table is a highly versatile modular table, offering the flexibility to combine multiple pieces and create any desired size, without limitations. Its rectangular shape enhances this modularity, allowing it to adapt easily to various spaces and requirements. This model is fully customizable, both in dimensions and materials, enabling it to perfectly match the specific needs of any workspace. In addition, the Verona table is designed to integrate advanced technology, including connection boxes, outlets, USB ports, and a cable management tray, helping to maintain a clean, organized space free from visible cables. With its combination of functionality and modern design, the Verona table is the ideal solution for dynamic and collaborative meetings.

La mesa de reuniones Verona es una mesa modular que ofrece máxima flexibilidad, permitiendo unir varias piezas para crear la configuración deseada, sin límites en tamaño. Su forma rectangular facilita esta modularidad, adaptándose a distintos espacios y necesidades.

Este modelo es completamente personalizable, tanto en dimensiones como en materiales, lo que permite que se ajuste a los requisitos específicos de cada entorno de trabajo.

Además, la mesa Verona está diseñada para integrar tecnología avanzada, como cajas de conexión, enchufes, puertos USB y una bandeja pasacables, ayudando a mantener el espacio limpio y organizado, sin cables visibles. Esta combinación de funcionalidad y diseño moderno hace de la mesa Verona una opción ideal para reuniones dinámicas y colaborativas.





Custom length and width.
Longitud y ancho personalizados.



Custom material choice.
Elección de material personalizada.



Flexible digital solutions.
Soluciones digitales flexibles.



Packaging = Wood + Cardboard + Edge Foam.
Embalaje = Madera + cartón + espuma.



Multiple edge choice.
Múltiples opciones de bordes.



Selection of wood grain direction.
Selección de la dirección de la veta de la madera.



Hybrid metal and wood structure.
Estructura híbrida de metal y madera.



Corporate logo option.
Opción de logotipo corporativo.



Personalised marquetry design.
Diseño de marquetería personalizado.



Removable panels or legs.
Paneles registrables o patas.



First class material.
Material de primera clase.



Quote and presentation within 24 hours.
Presupuesto y presentación en 24 horas.



BESPOKE / MODULAR TABLE





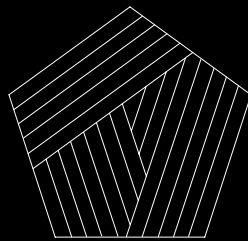

SPAIN OFFICE

Avenida generalitat valenciana nº40
castellón
SPAIN

USA OFFICE

Whitewater Ln, Oswego, IL 60543
USA

FACTORY

Barrio el Gamonal, 6, 39715 Ceceñas
Cantabria
SPAIN

www.MATT-LINE.com
admin@matt-line.com
export@matt-line.com